

Mobile Installation Clinic

Your Host:

Lon

KØWJ

June 2010 – Vidalia, LA - 3905 Century Club Mobile Shootout - 1st Place

October 2010 – Indianapolis, IN – Indy Radio Club Shootout - 1st Place

August 2011 – Taos, NM - ARRL Rocky Mountain Convention Shootout - 1st Place

August 2011 – Onalaska, WI – Mississippi Valley ARA Shootout - 1st Place

September 2012 – Onalaska, WI – Mississippi Valley ARA Shootout - 1st Place

September 2013 – Onalaska, WI – Mississippi Valley ARA Shootout - 1st Place

Topics:

*** Power

*** Coax

** Noise

* Antenna (Mounting *****)

***** Grounding / Bonding

***** Common Mode Choking

Power

Use the proper size Wire and Type

Generally accepted current ratings:

10 Amps	18 gauge
15 Amps	14 gauge
20 Amps	12 gauge
30 Amps	10 gauge
45 Amps	8 gauge
60 Amps	6 gauge
80 Amps	4 gauge
100 Amps	2 gauge
125 Amps	1 gauge
150 Amps	0 gauge

Cable Routing:

Routing through firewalls is more difficult in most cases.

Puts your wiring too close to ignition wiring and other automotive circuits.

Better to route under chassis and use factory knockouts to enter vehicle. Weatherproof fittings available at Lowe's, etc.

NEVER use solid gauge wire in any mobile installation. Check out your local welding supply outlets or Tractor Supply for super-flexible cabling.

Always fuse both leads as close to the battery as possible

Consider using circuit breakers (available on eBay.com - \$10/ea. for 80 amps)

Anderson Power Pole connectors facilitate easy installs

Use with West Mountain Radio or MFJ Distribution boxes

80 Amp Circuit Breaker

(Other Sizes Available)



Available on eBay for \$10.95



**See Notes Page for
An explanation**

CAUTION: NON-REMOVABLE ENCLAVE
DOES NOT PROVIDE PROTECTION
BETWEEN CONDUCTIVE COMPONENTS

WARRANTIA
DE GARANTIA
PRODUCTO

HEATPRO MARK 2

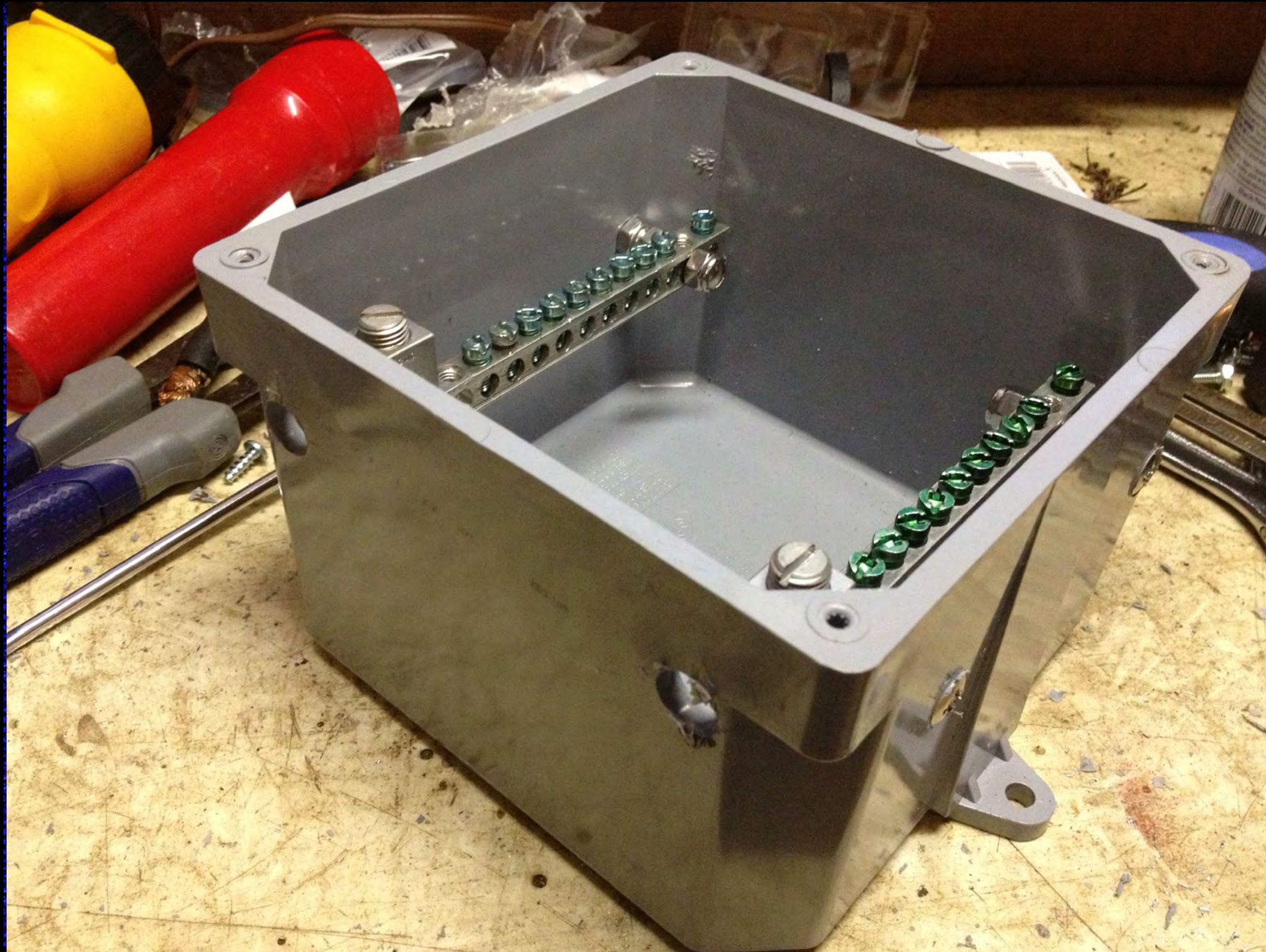

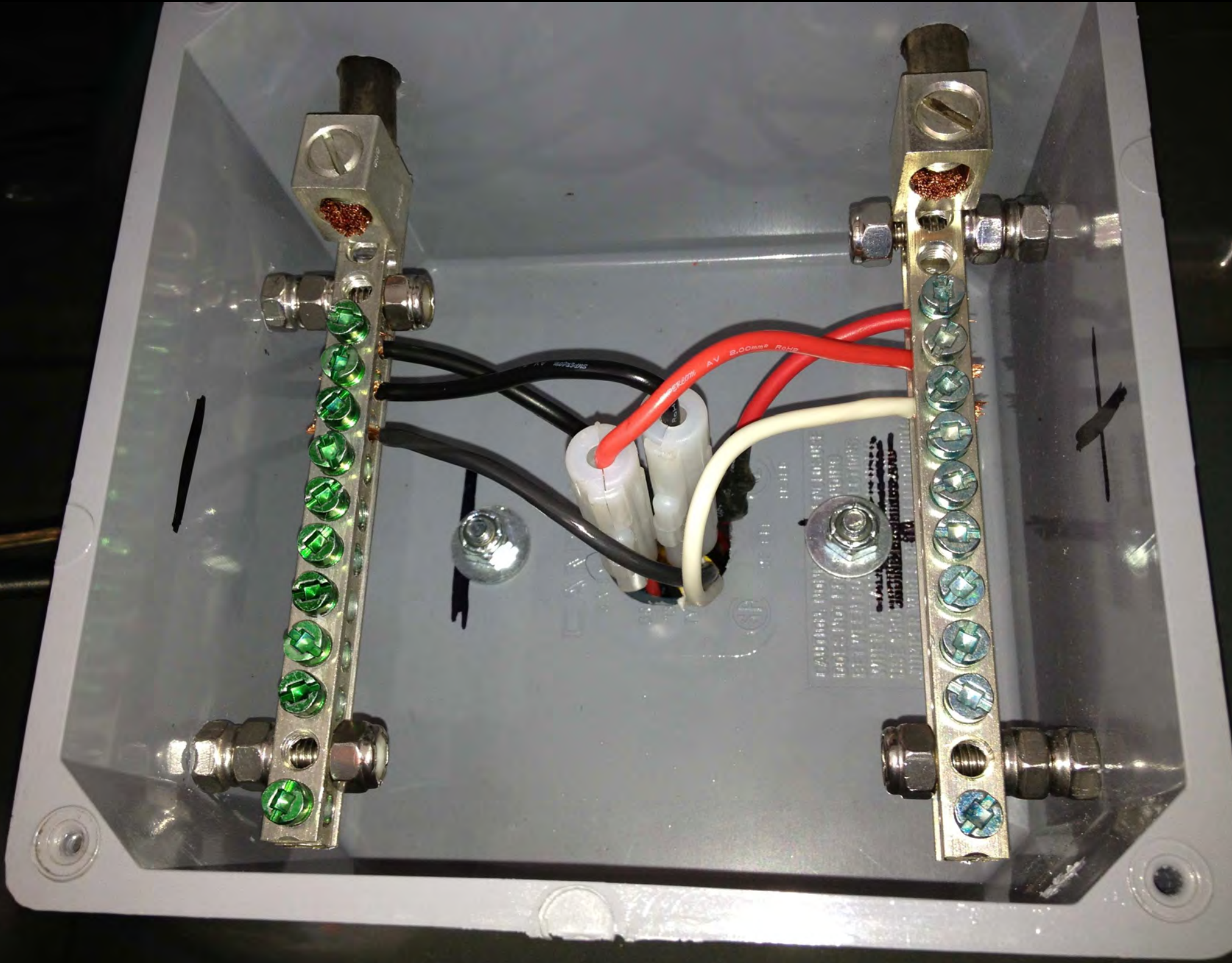

Coax

NEVER use a solid center conductor coax in any mobile installation

RG-8X is the best solution for 95% of all mobile installations

RG-8X will handle full legal limit with the short runs in a mobile

RG-8X comes in many flavors – some are good and others are not as well suited for mobile operations (some are NOT very flexible)

Flexibility becomes even more important as will be seen in the Common Mode Choke discussion later in the presentation

Noise

How does the noise manifest itself?

Is it in cadence with the engine or wheels?

Is it more than the radio's noise blanker can handle?

How do I find the source?

Once the source is identified, how do I cure it?

Noise

How do I find the source?

The "Sniffer"



Two or three 1" diameter turns of #14 enameled wire creates a horrible antenna with a wide bandwidth for "Sniffing" out noise

Antenna

Mount it in the best location possible – higher is better

In the case of center loaded antennas, make sure the coil is above the roof line and clear of metal objects

Make sure shunt coils are away from body sheet metal

Antenna

Bigger is badder...I mean better

Mobile antennas are ALWAYS a compromise

Resonate your antenna

Match your antenna to your coax (50 ohms)

In most cases a shunt coil is the best way

Shunt coils can quiet down a noisy antenna due to their inherent DC grounding attribute

Antenna

Matching with a Shunt Coil

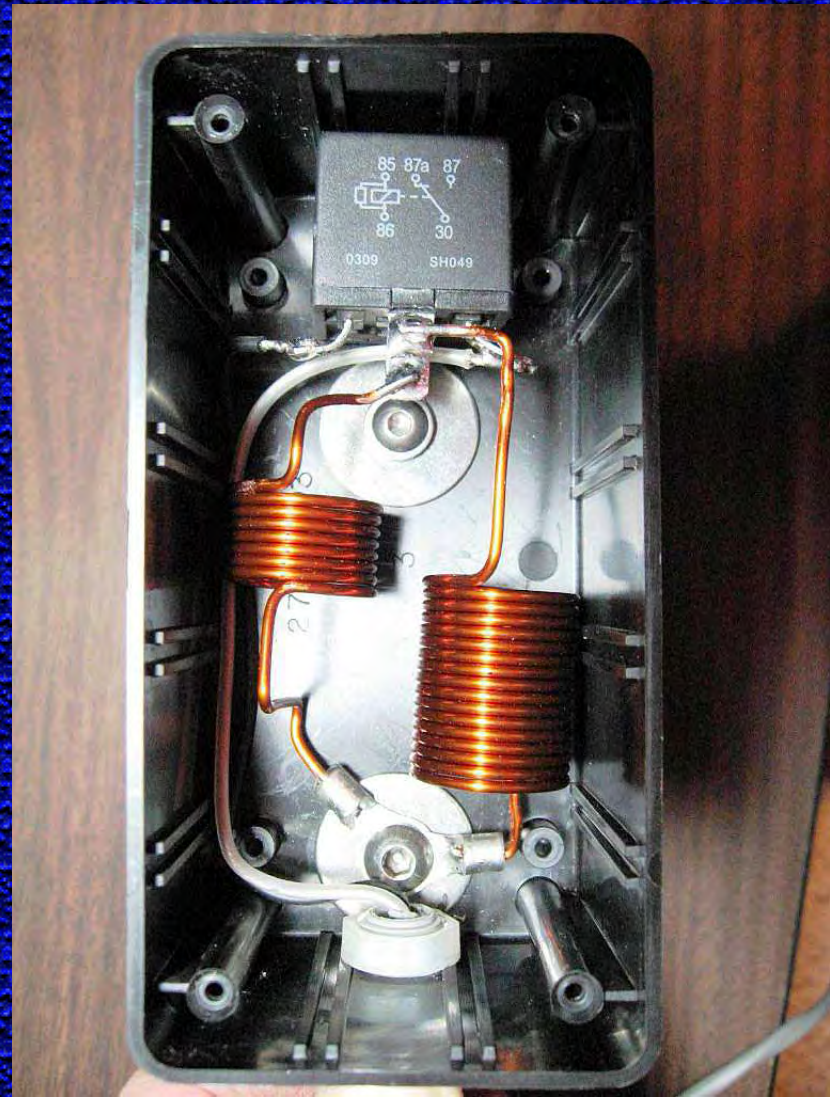
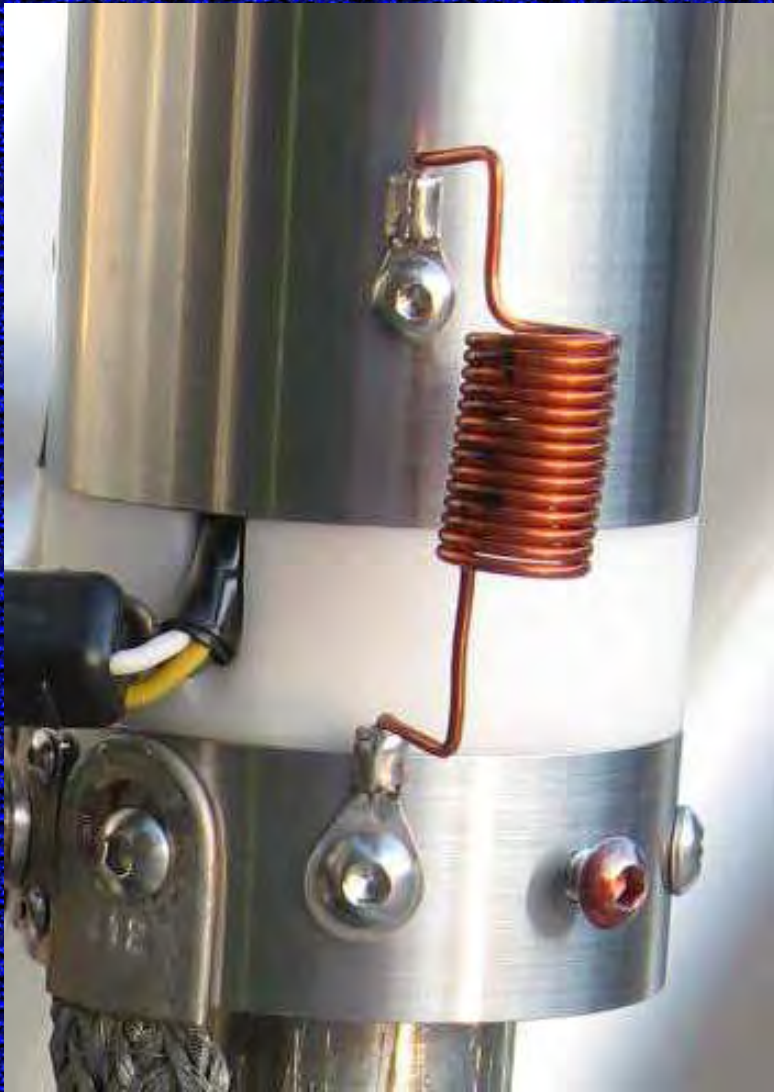

Antenna

Matching with a Shunt Coil



Antenna

“ A vehicle is not a ground plane. Rather it acts like a capacitor between it, and the surface under the vehicle which is the true ground plane. Since the surface in question is a poor conductor of RF, ground losses occur.”
- Alan Applegate, KØBG

Any antenna should be attached in such a way to maximize the capacitive coupling to ground. The key phrase here is: **it is the metal mass directly under the antenna, not along side, that counts!**

Antenna

A mobile vertical antenna is $\frac{1}{2}$ of the antenna. The missing half is normally made up using radials – not possible in a mobile HF installation, so we rely on the mass of the vehicle and the capacitive coupling of the vehicle to the surface under it.

Get a firm grasp on this concept, for it is the single most important take-away from this presentation

Antenna

It is the metal mass directly under the antenna, not along side, that counts!

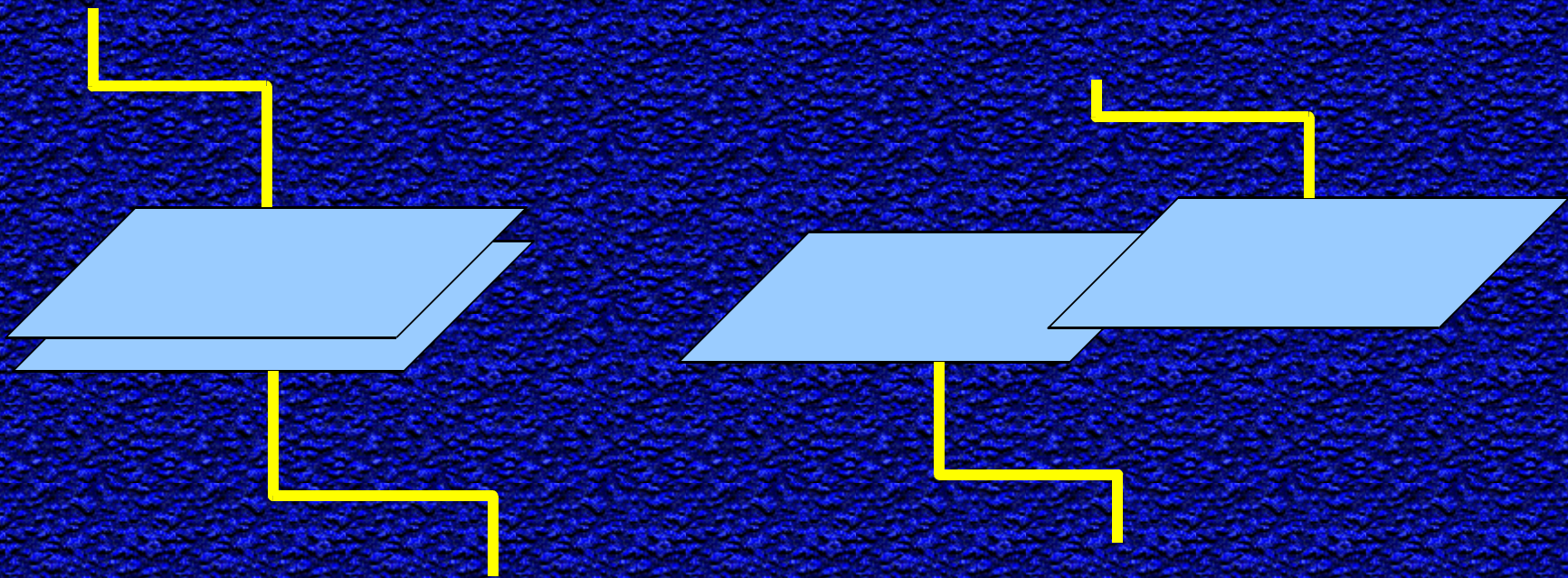

Which capacitor above offers the highest capacitance or coupling between the wire leads?

Antenna

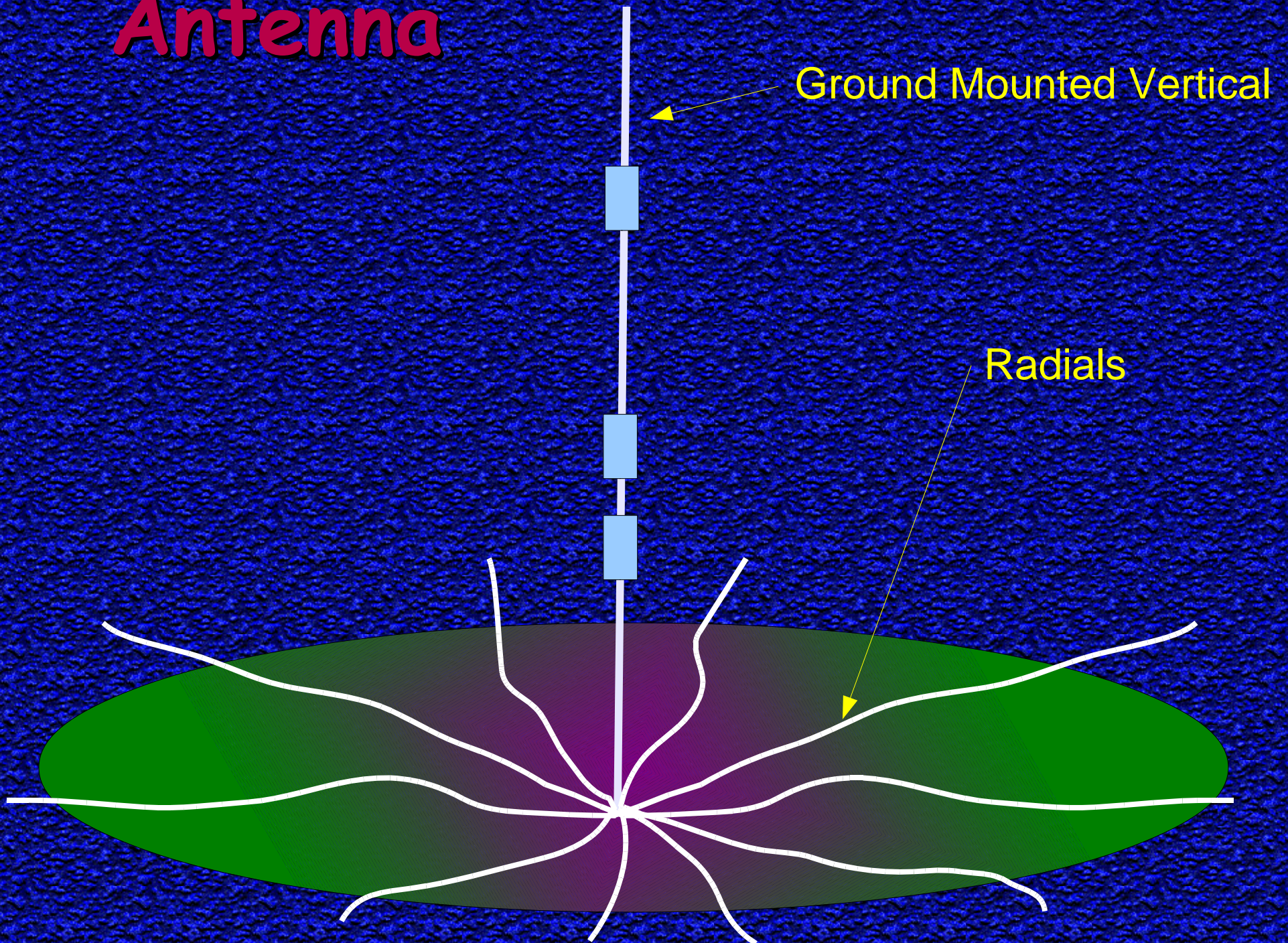

Antenna

Ground Mounted Vertical

Radials

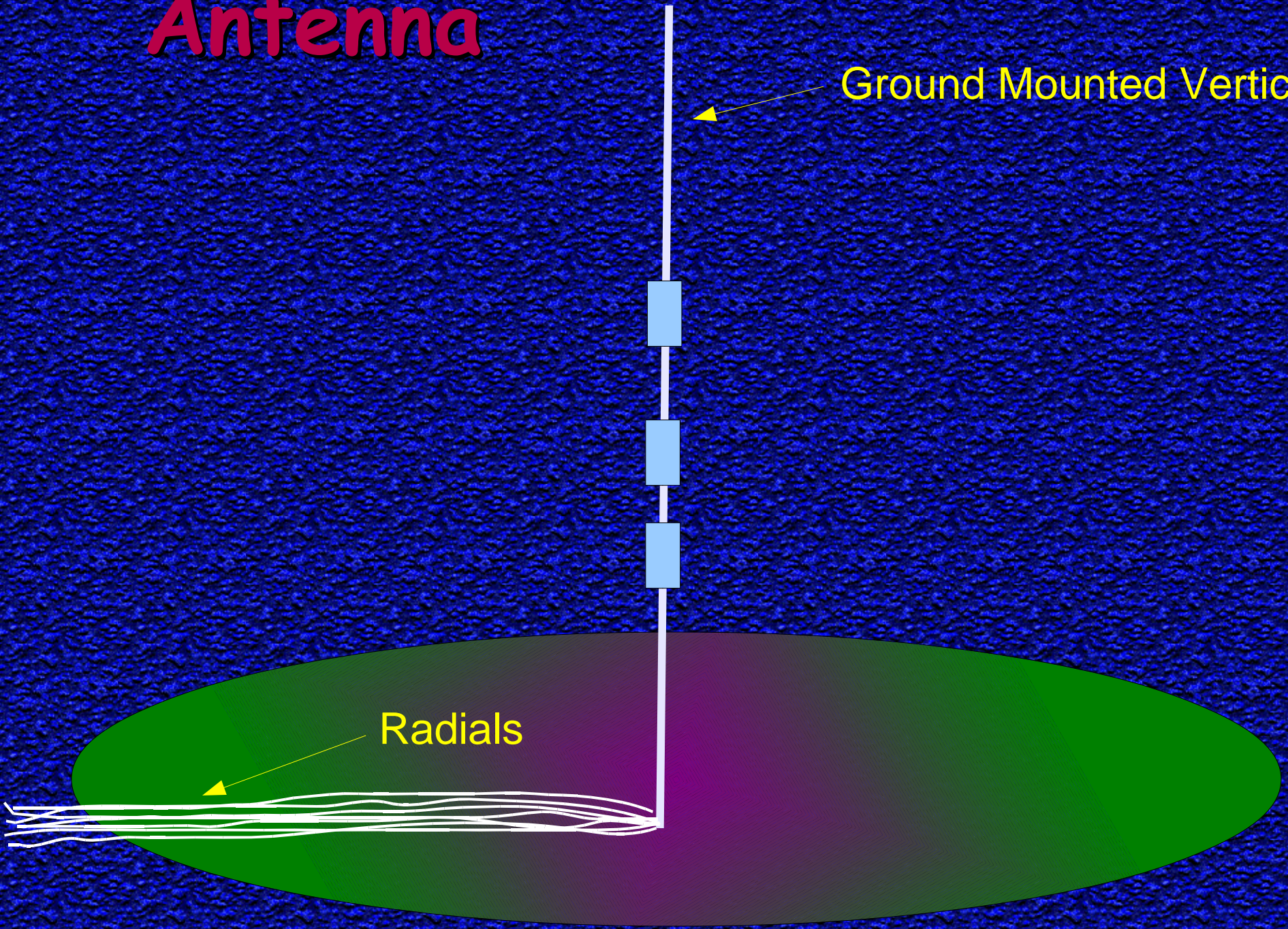

Antenna

It is the metal mass directly under the antenna, not along side, that counts!



Again, which capacitor above offers the highest capacitance or coupling to ground?

Antenna - Cap Hats

Cap Hats can make a huge difference

Best is a solid metal, 8 foot in diameter disk, at least 60" above your main coil, but not practical for mobile

Cap Hats mounted 2 feet or less above main coil degrade over all performance – 60" above is optimal

Most use a 3 or 4 leaf clover configuration at least 3 or 4 feet in diameter

Examples

Antenna - 160 Meters

More Loading

Add-On Inductors

Will your current antenna be able to support the additional mass?

More Length

Add-On Masts and longer Whips

Grounding / Bonding

(NOT the same thing)

Grounding is for electrical considerations

Bonding is for RF considerations

Ground ALL of your Ham Radio apparatus to the chassis of the vehicle - use a minimum of 3/4" wide braid

Bond doors, hood, trunk lid, hatch back, etc using a minimum of 3/4" wide braid at the hinges.

Bond vehicle body to the frame at multiple locations

Grounding / Bonding

(NOT the same thing)

Grounding is for electrical considerations

Bonding is for RF considerations

Bond pickup truck bed to the frame

Bond engine block to the frame in at least one additional location – more is better

Bond exhaust system at multiple points to the frame
Exhaust System bonding will tend to help eliminate noise on receive as the exhaust pipe acts like an antenna and broadcasts ignition noise to your receiver.

After all bonding is complete, it is not unusual to have to re-resonate your antenna

Grounding / Bonding

(NOT the same thing)

Grounding is for electrical considerations
Bonding is for RF considerations



WB11

Grounding / Bonding

(NOT the same thing)

Grounding is for electrical considerations
Bonding is for RF considerations



Exhaust
Pipe
Bonding

KØWJ

Grounding / Bonding

From an RF standpoint, the resulting ground plane is wholly inadequate, and as a result the ground plane losses are high.

It should be clearly evident then, that minimizing ground losses are important, both from an efficiency standpoint, and in curbing both ingress and egress RFI. Bonding is one way to do this.

Improper antenna mounting is the number one cause of unwanted Common Mode Current!

Common Mode Choking

What are Common Mode Currents?

“Almost without exception, all RFI ingress problems are caused by one of two scenarios. First, is common mode current flowing on the outside of the coaxial feed line. The second cause is inadequately choked motor control leads. Both scenarios are exacerbated by poor antenna mounting and/or location resulting in excessive ground plane losses.”

- Alan Applegate, KØBG

For some real insight into Common Mode Currents, what they are and what the causes are, please visit:
http://www.w8ji.com/verticals_and_baluns.htm

Common Mode Choking

Question: How many independent conductors at RF frequencies do we have in a coaxial cable?

- A. One
- B. Two
- C. Three
- D. Four



Answer: C. Three

- The Center Conductor
- The Inner Surface of the Shield
- The Outer Surface of the Shield

Common Mode Choking

Note: The RF current that flows on the outer surface of the shield is independent of the inner shield current.

This is so, because at RF frequencies, the current penetrates very little inside the conductors. This is called SKIN EFFECT.



Note also that the SWR only applies to the inner shield currents and center conductor. The SWR is independent of the outer shield currents.

Common Mode Choking

Note: The RF current that flows on the outer surface of the shield is independent of the inner shield current.

This is so, because at RF frequencies, the current penetrates very little inside the conductors. This is called SKIN EFFECT.



Note also that the SWR only applies to the inner shield currents and center conductor. The SWR is independent of the outer shield currents.

Question: What should be the maximum amount of current allowed on the outer surface of your coax feed line?

Current Probe

http://www.w8ji.com/building_a_current_meter.htm

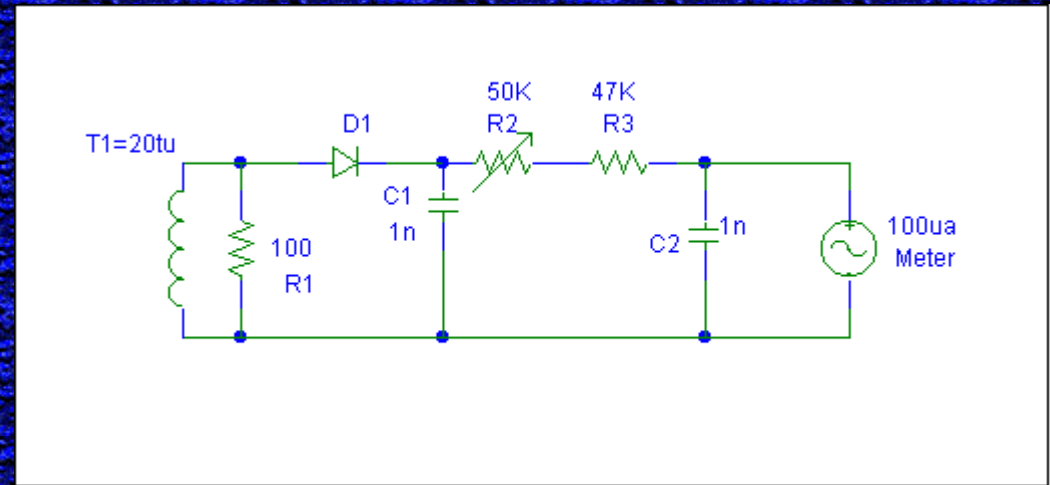

T1 T157-2 Core wound w/20 turns
C1, C2 .001 μ f disc capacitor
D1 1N34
R1 100 Ω
R2 50k Ω Potentiometer
R3 47k Ω
Meter 100 μ A

Current Probe - Feb. 1999

by:
Steve Sparks, N5SV
(now WK5S)

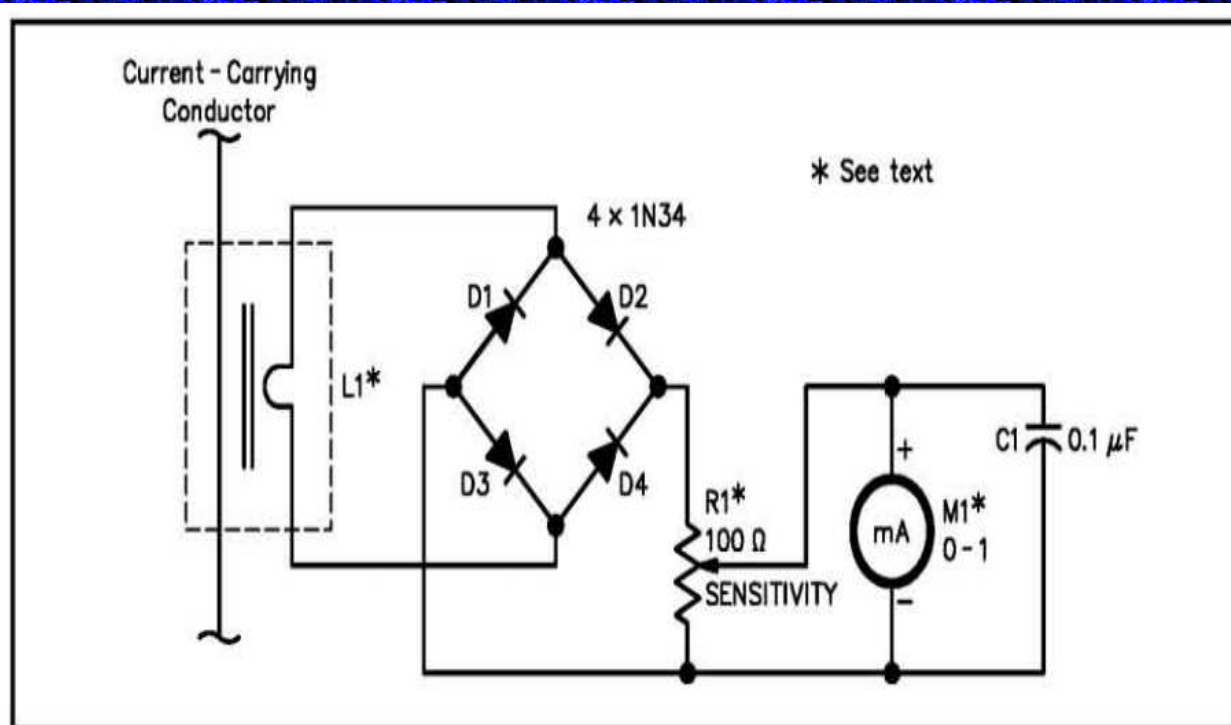

Figure 1—Schematic of the RF current probe. Unless otherwise specified, resistors are 1/4 W, 5% tolerance carbon-composition or film units. Part numbers in parentheses are RadioShack. Equivalent parts can be substituted.

C1—0.1 μF disc ceramic (RS 272-135).

D1-D4, incl—1N34 germanium diode (RS 276-1123); do *not* use silicon diodes.

L1—Single turn of #14 wire through a snap-on ferrite choke (RS 273-105); see text.

M1—0-1 mA or greater sensitivity; (an RS 22-410 can be used without the series multiplying resistor supplied as it's a 0-1 mA movement meter.)

R1—Panel-mount pot, 100 to 500 Ω; 10-turn pot used here.

Misc: Enclosure, knob, hardware, adhesive.

QST



Current Probe

MFJ-853

CLAMP-ON RF CURRENT METER



MFJ-853

Price: \$59.95

MFJ-854

RF CURRENT METER



MFJ-854

Price: \$110.65

Common Mode Choking

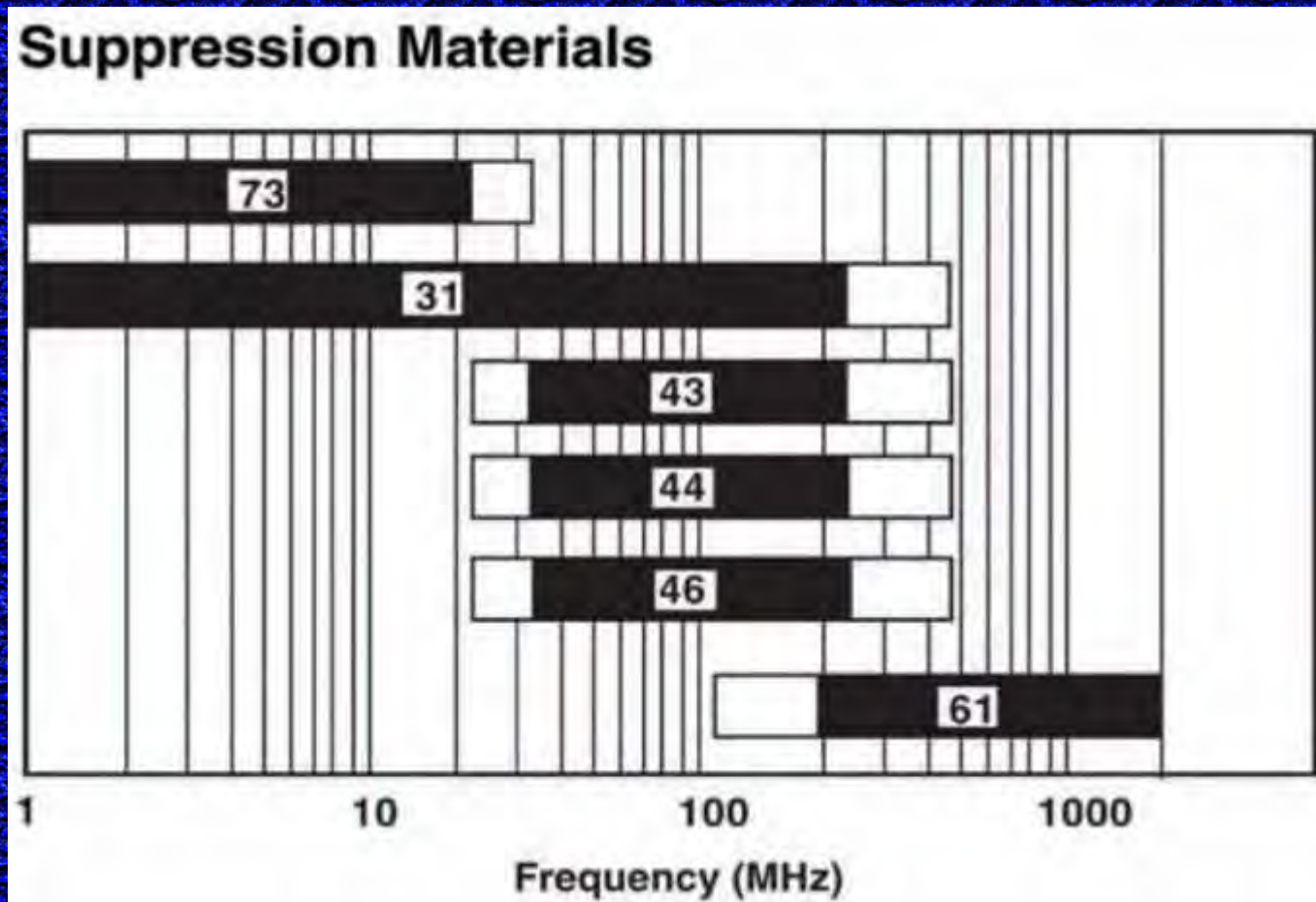

Now, let's look at some real world testing

What about all those
Toroids in my junk box
or the ones I see at
Hamfests all the time?

This is the test fixture that Allen, KC7O, designed to check the spectrum blocking ability of some unknown toroids.

From QST
Feb 2012
"Hints and Kinks"



With only a 50 ohm resistor across the output, the Analyzer will show a 1:1 SWR at 50 ohms on most frequencies.

With a wire shorted across the output, the Analyzer will show infinite SWR at \emptyset ohms on most frequencies.

Winding this wire on the Toroid in question will show the effectiveness of the Toroid under test. Run through a range of frequencies to see where it is most effective. Of course the goal is to find a Toroid that makes the wire look like an open circuit as if the wire was not even there.

Common Mode Choking



The best way to control common mode currents is with a choke. You can use the same type of choke that you use for the motor control leads. That is, mix 31 split beads, and preferably the 3/4 ID units. They can be purchased from DX Engineering and others. These will allow 6 to 7 turns of RG58, and 5 to 6 turns of RG8X (as shown in photo). Note that the coax is not tightly wound around the choke. In this case, the diameter is about 3 inches. Any tighter, and the core could migrate and cause a short.

Now, let's look at some real world testing



Type 31 Bead for motor control leads



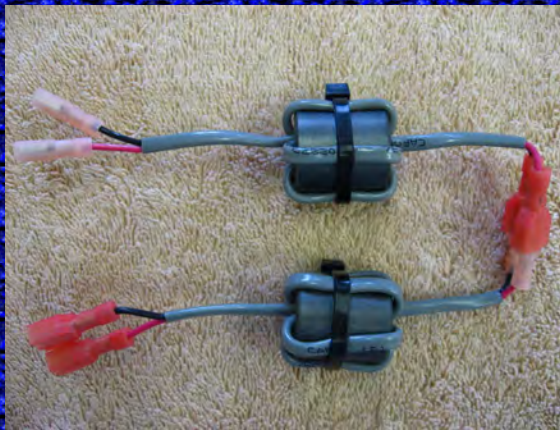

Type 31 Beads X2 with Motor Control Leads

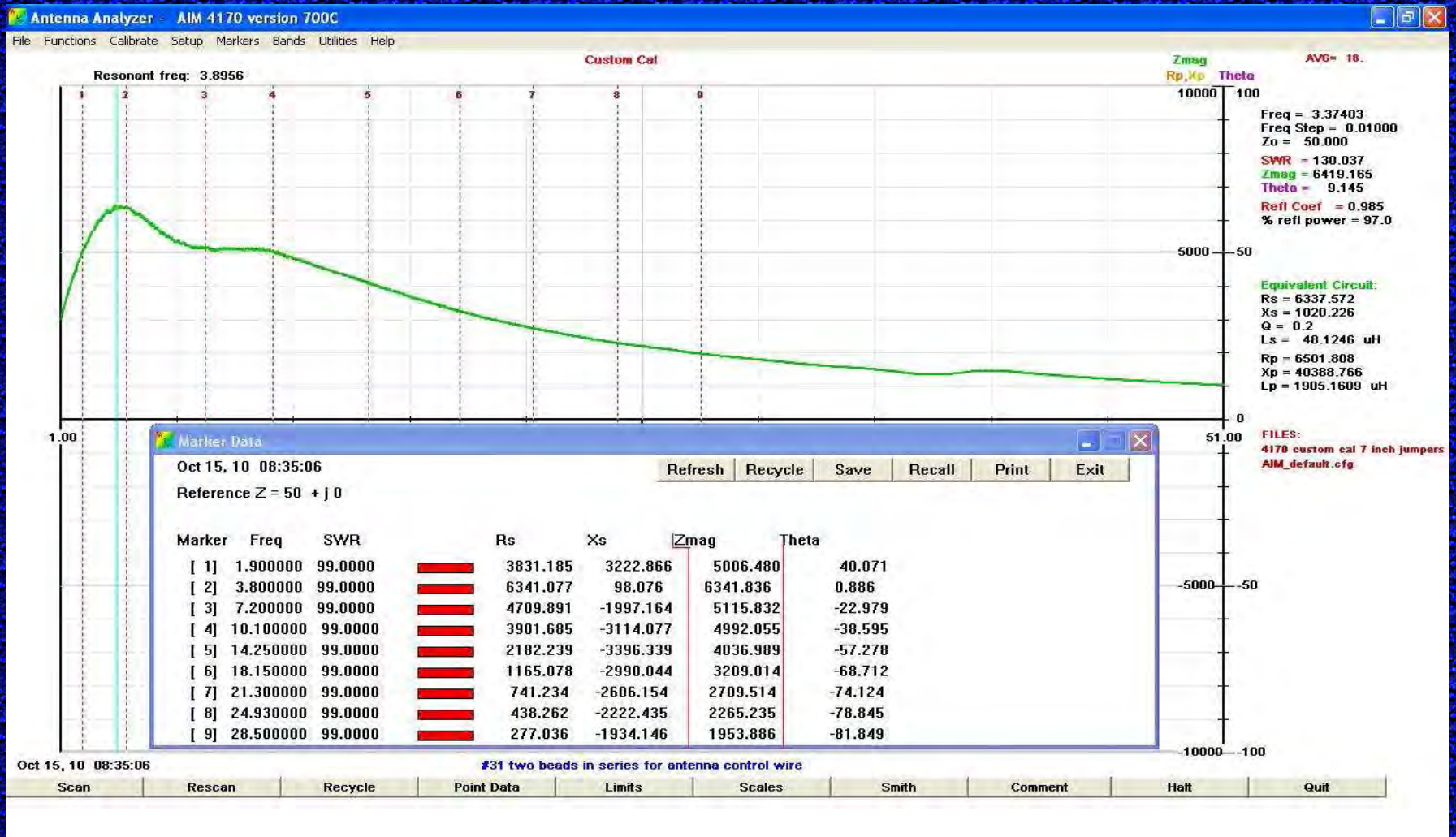



Type 31 Beads X3 with Motor Control Leads

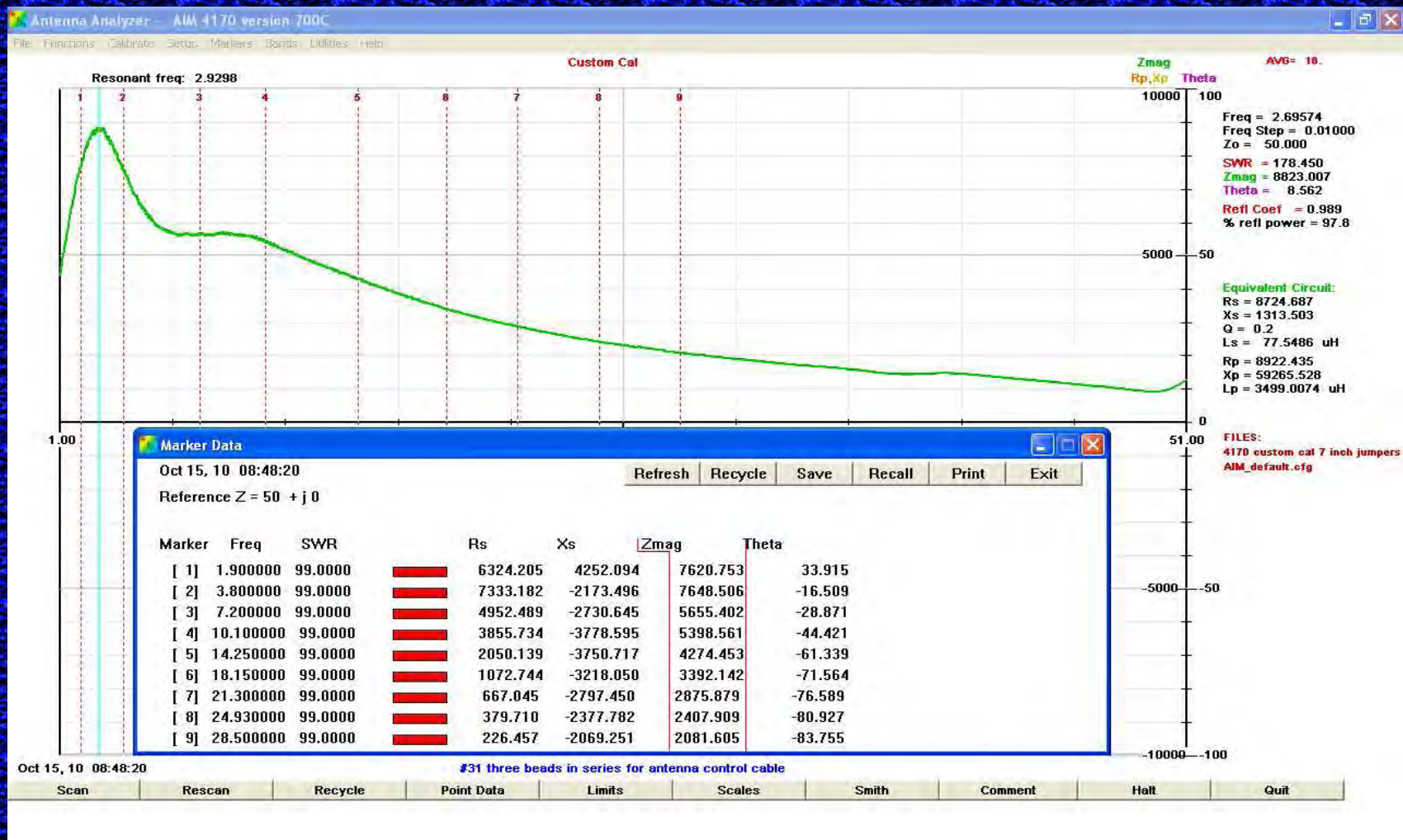



Type 31 Toroid for motor control leads

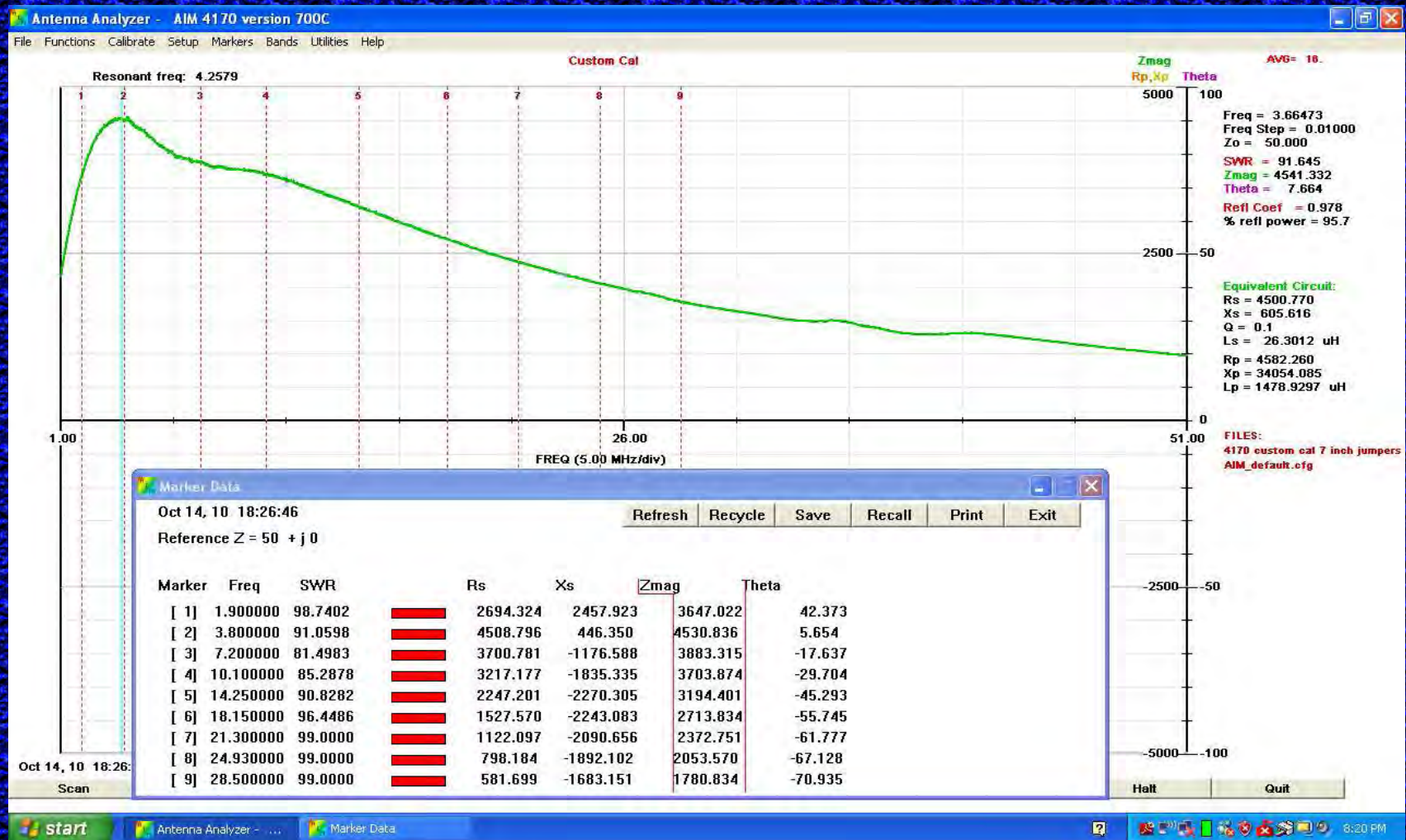



Type 77 Material with Motor Control Leads

(Not even close to the choking capabilities of Mix 31)

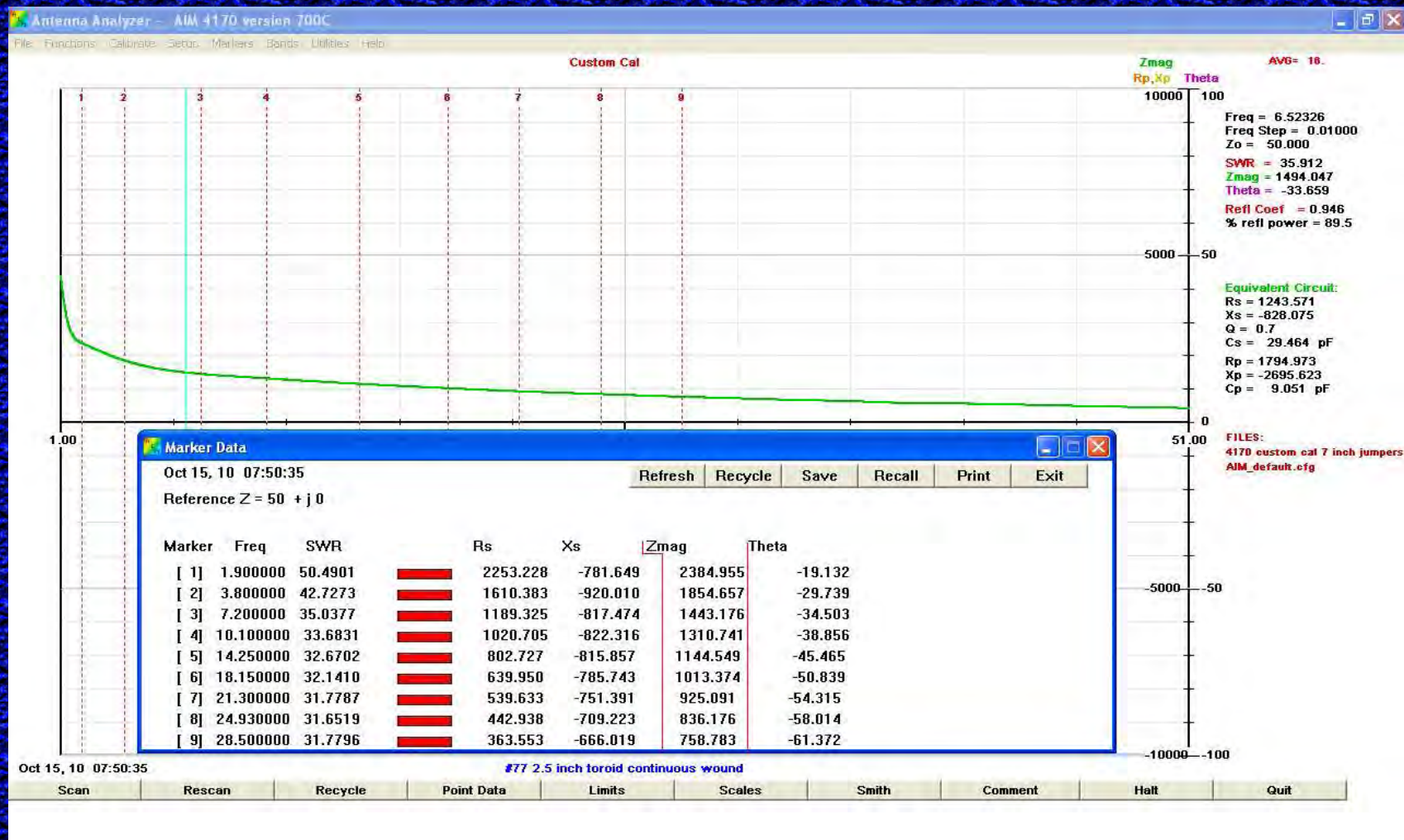



Type 31 Beads X10 with RG-8U Coax

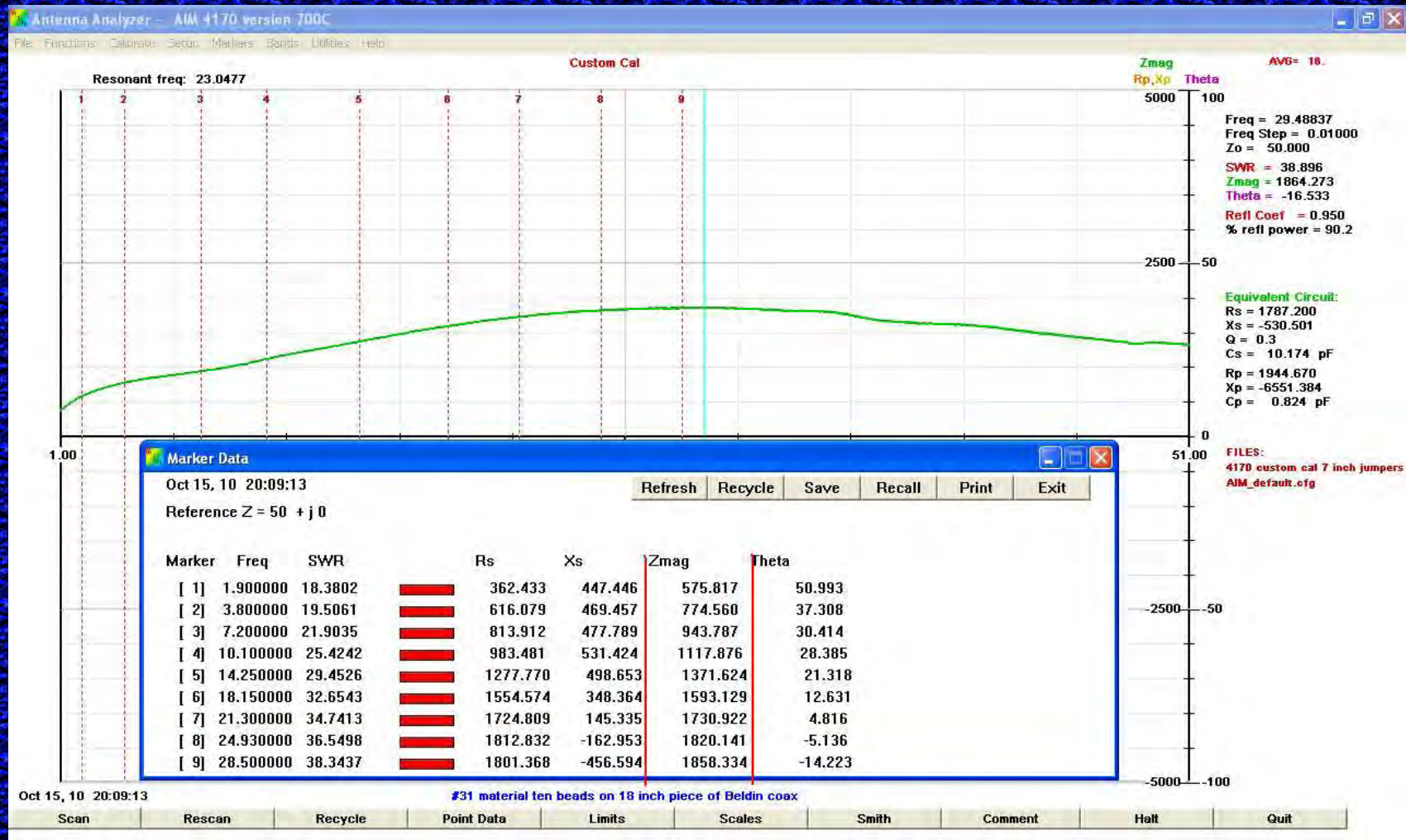



RG-213U Ugly Balun

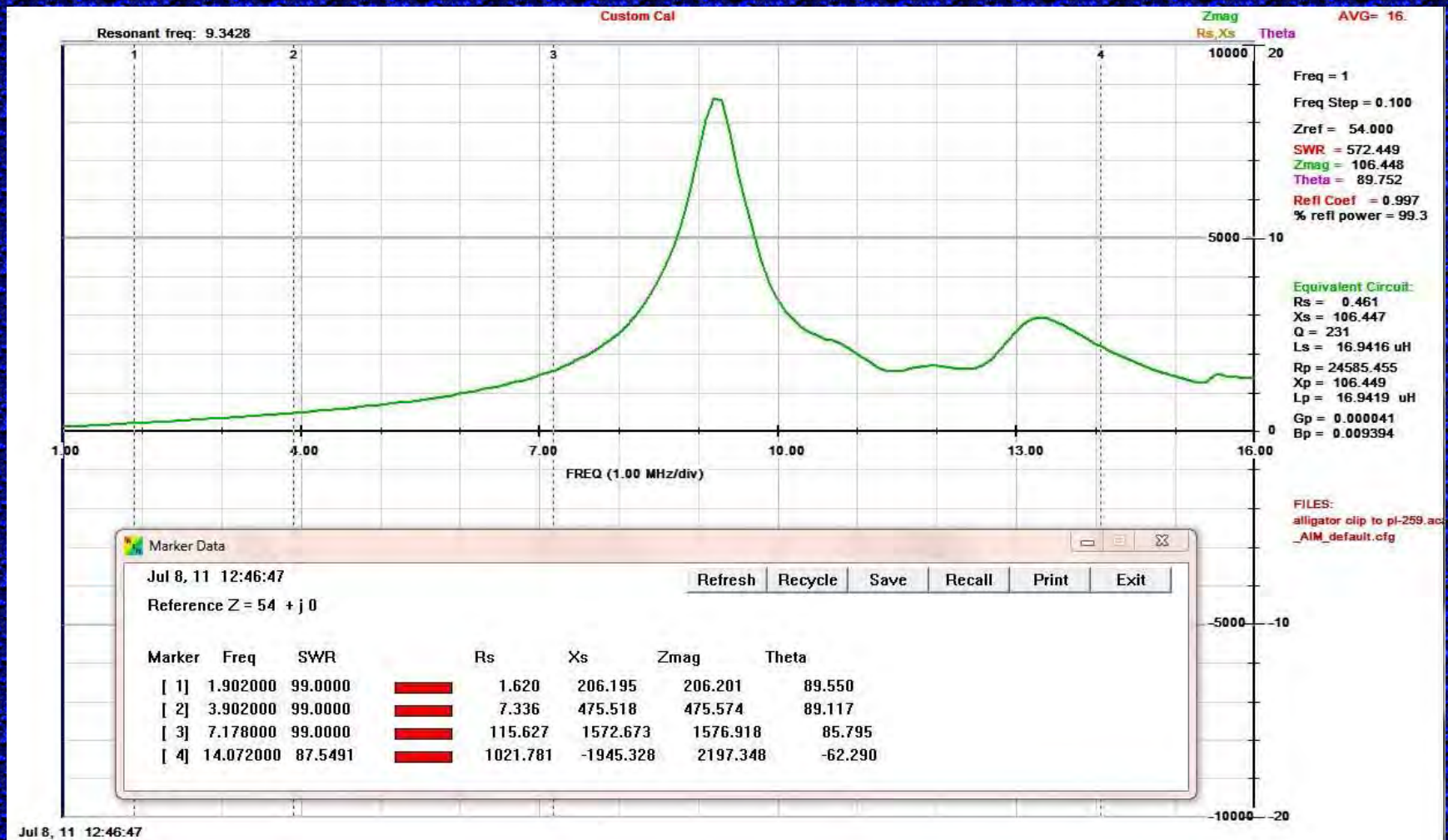



Type 31 Snap-On Beads and RG-8X Coax

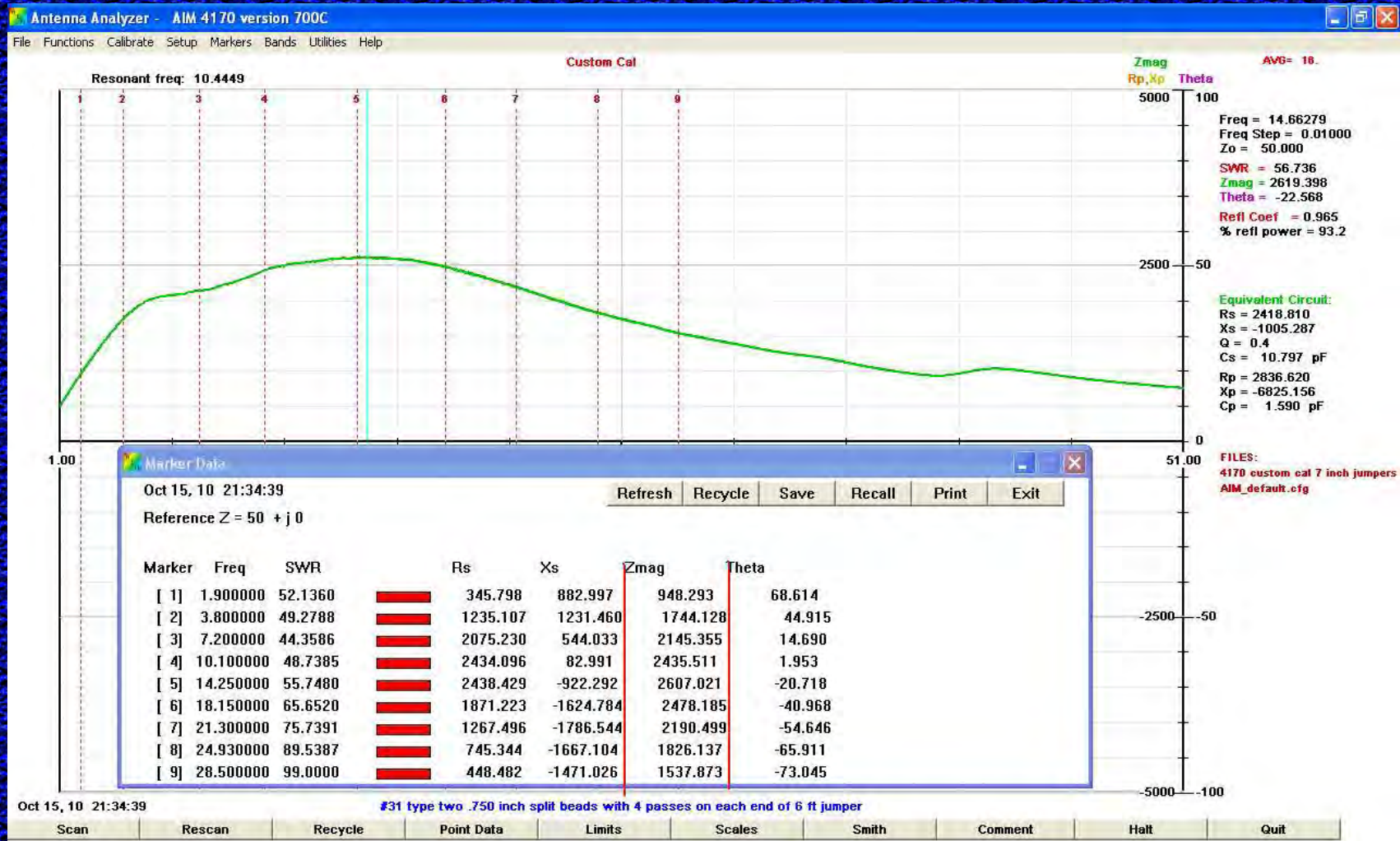



Type 31 Toroid and RG-303/U Coax

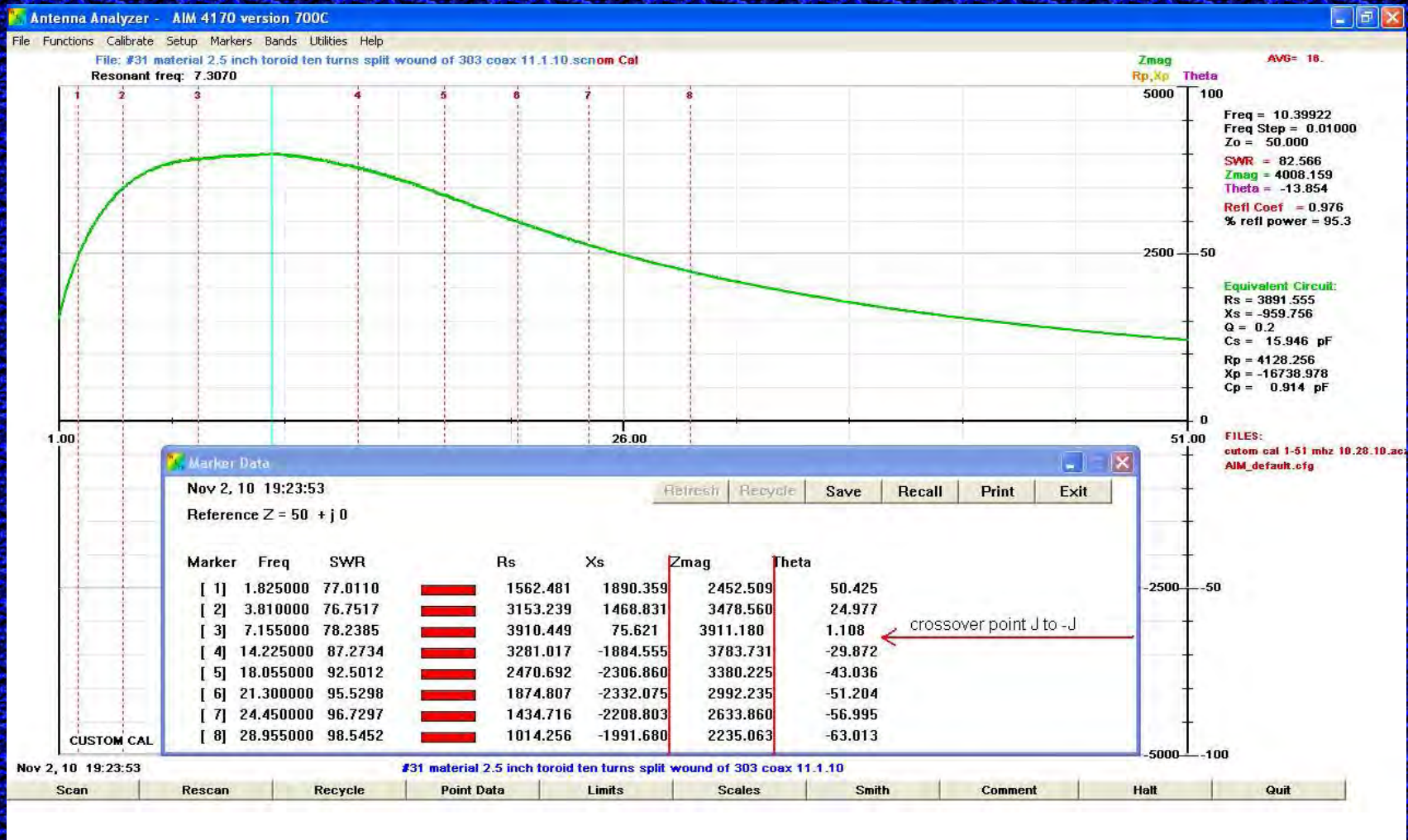



Type 31 Toroid and RG-303/U Coax



Type 31 Beads X4 and RG-303/U Coax

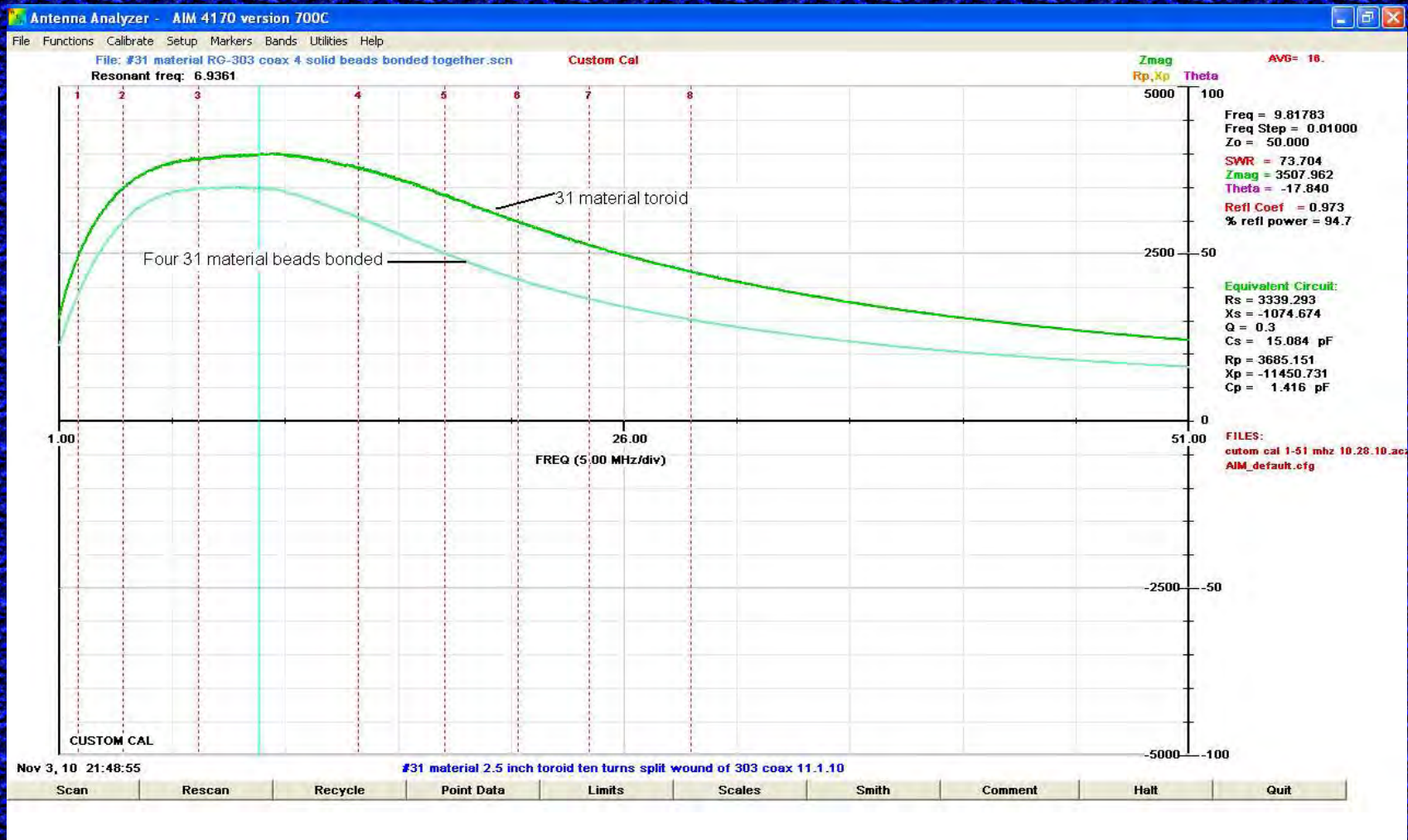

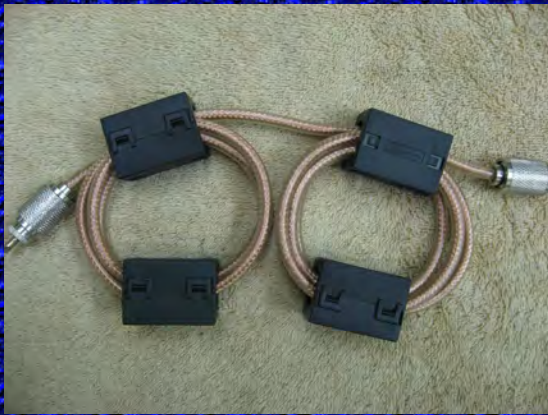

Type 31 Snap-On Beads X4 on RG-8X Coax

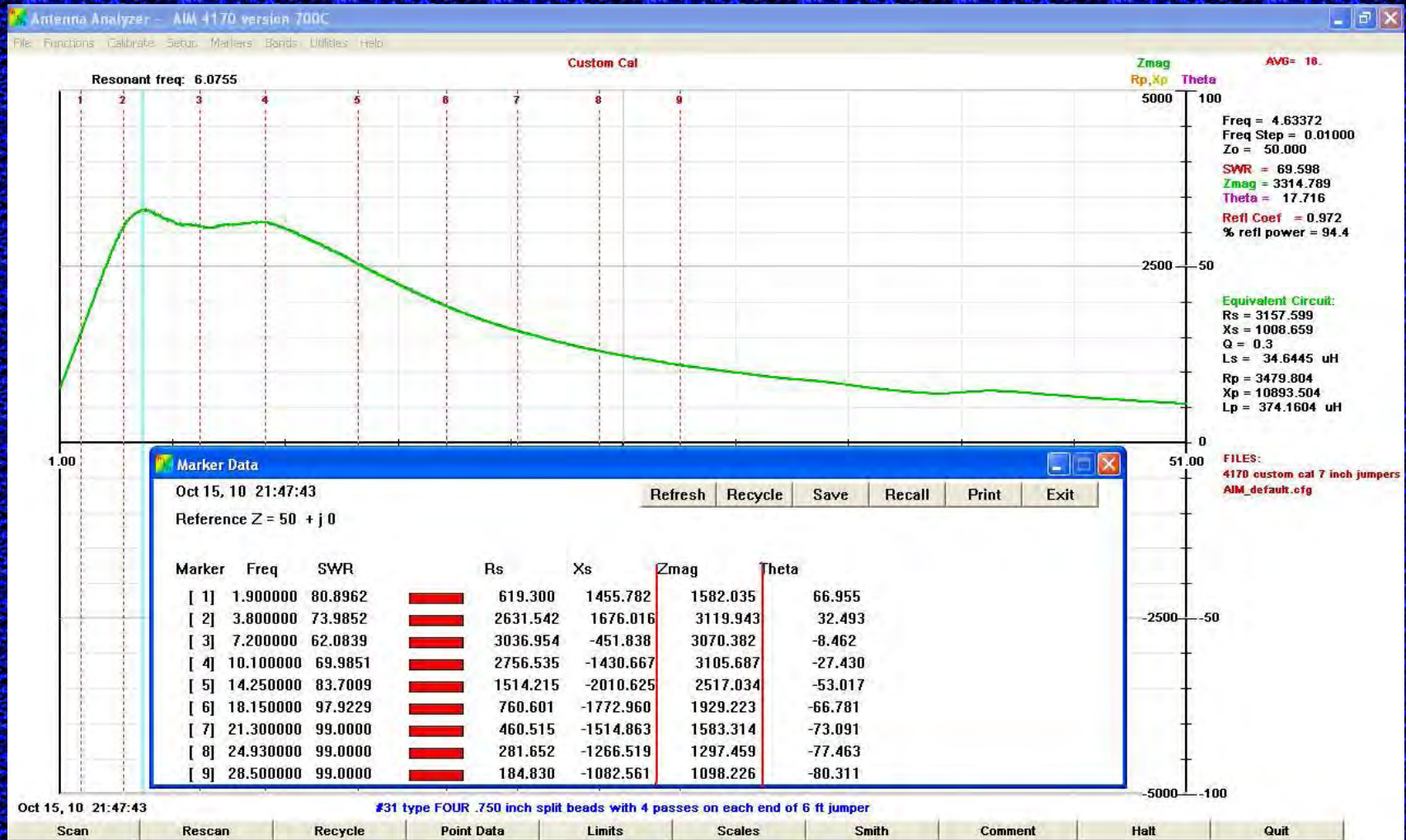



Type 31 Toroid X2 with
RG-8X Coax

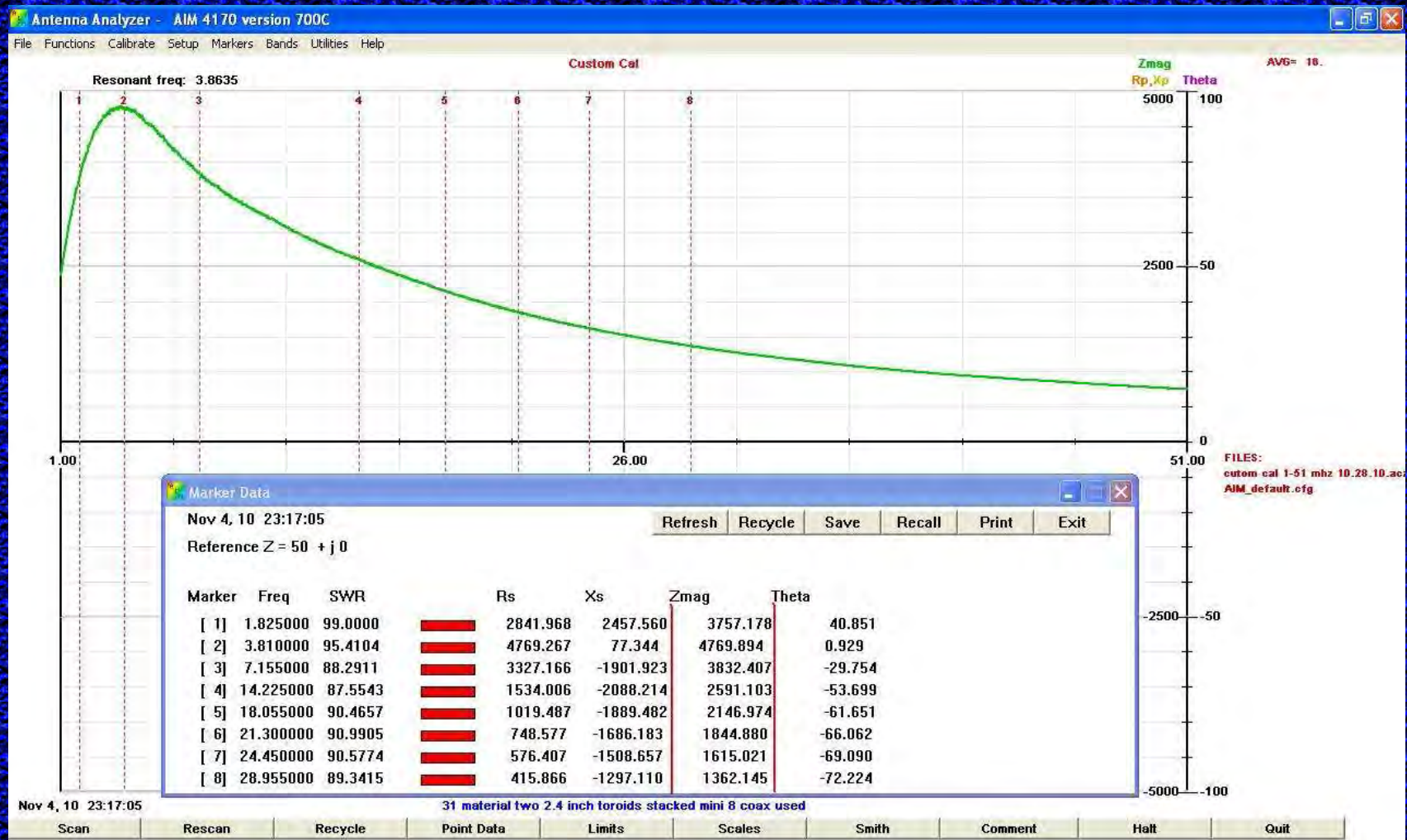

A Comparison

Blue Line – Type 31 Toroid X2 Stacked with RG-303/U Coax

Green Line – Type 31 Toroid X2 Stacked with RG-8X Coax

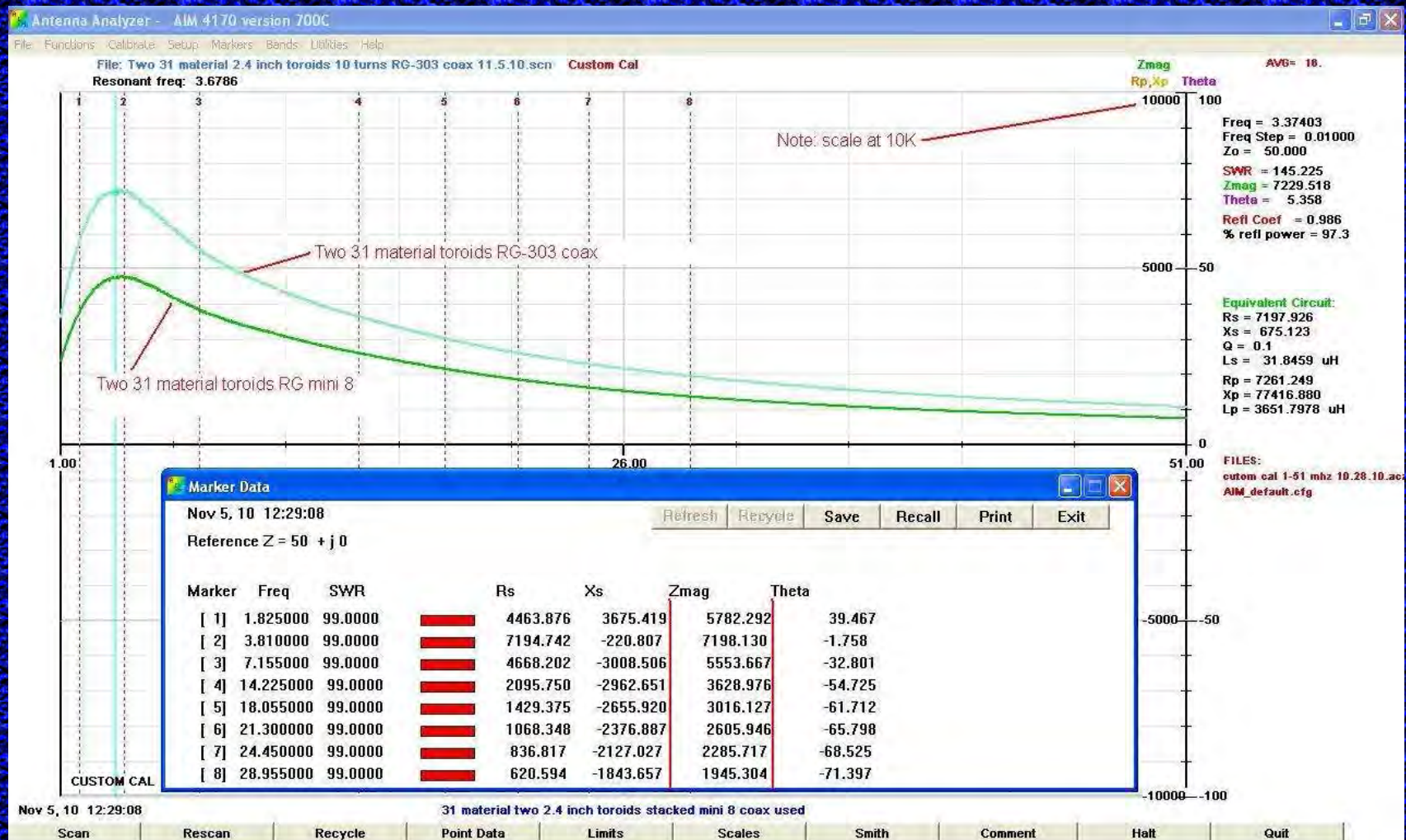

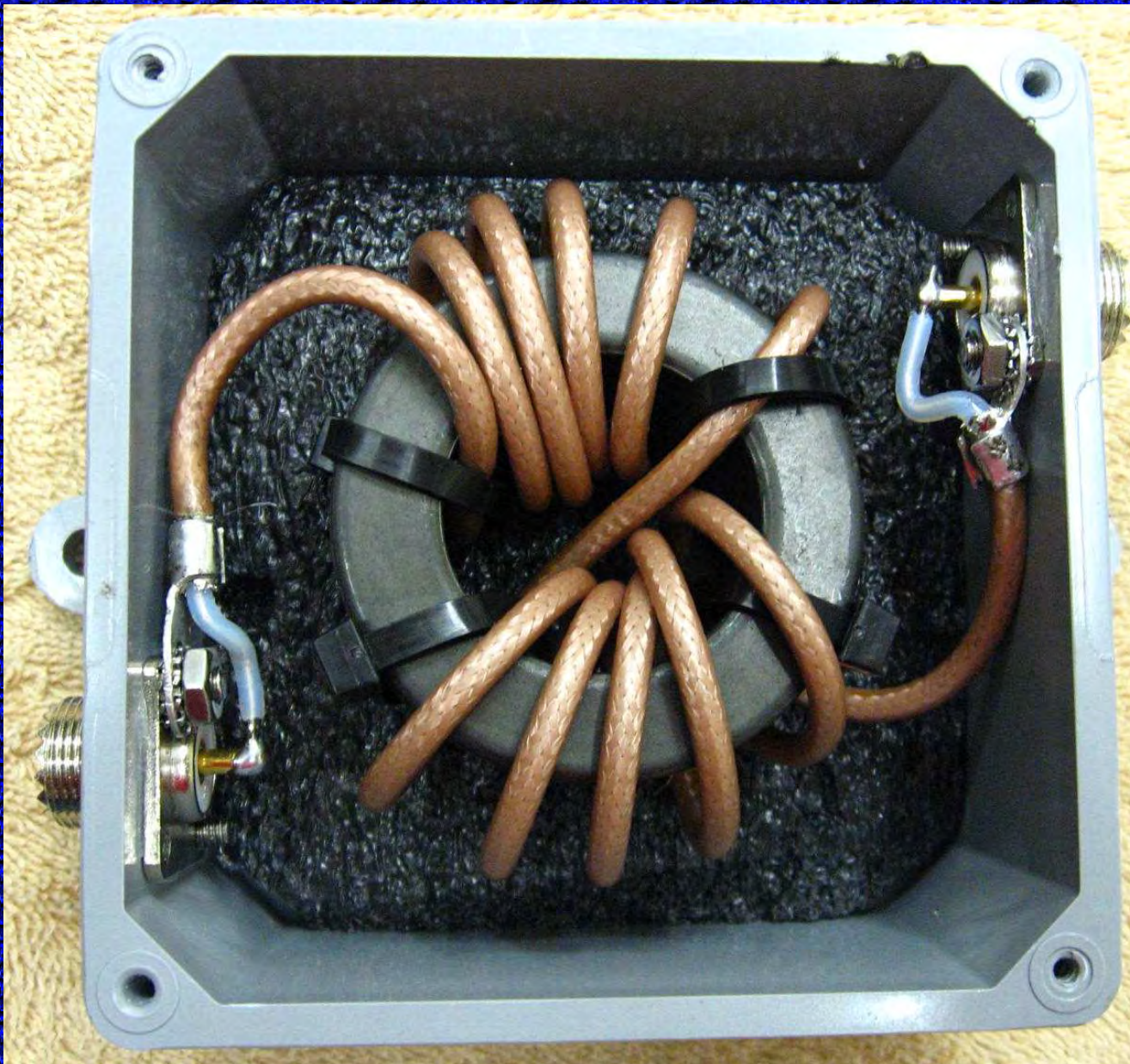

**1:1 Current
Choke**

**Available from
Scorpion
Antennas
\$50**

What Have We Learned?

Some Examples

14/14



WAØSIK - Fred

13/14



WF4H - Dwight

12/14



W9JAY - Jay



NAØL - RJ



WB11 - Fred



KB3PU - Jim



W2UJ - Russ

**Eyeball 2013
Torrington, WY**

1/14



KCØCL - Cal

2/14



WTØA - Glen

14/14

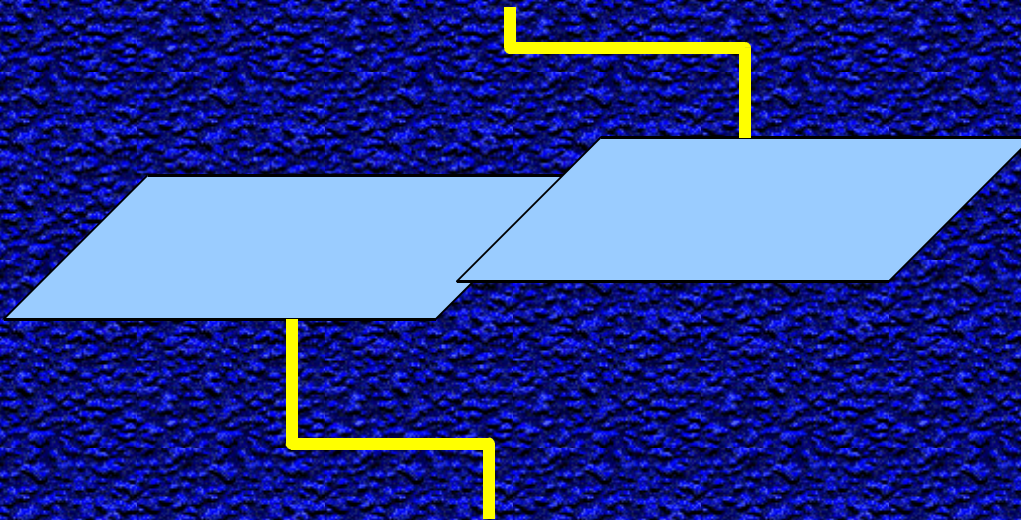

Nice-To-Haves

(Operating Conveniences)

Test Gear

Inductance/Capacitance Meter



L/C Meter IIB from:

Almost All Digital Electronics

<http://www.aade.com/>

Will provide a more precise way to build a Shunt coil at the correct value.

Kit: \$99.95

Pre-Built: \$129.95

Test Gear

Antenna Analyzers



MFJ-259C/269
\$269.95/\$334.95



RigExpert AA-600
\$584.95



Array Solutions AIM4170D
\$545.00



PalStar ZM-30
\$399.00

Test Gear



MFJ-834 RF Ammeter
\$79.95



PALSTAR PM2000AM Mobile SWR Meter
\$199.95



MFJ-819 Mobile SWR Meter
\$159.95

Test Gear



KC4YBO

Watt's Up Watt Meter Model WU100
\$59.95

<http://www.rc-cars-planes.com/buy-products.html>

Up to 60 vdc and up to 50 amps continuous

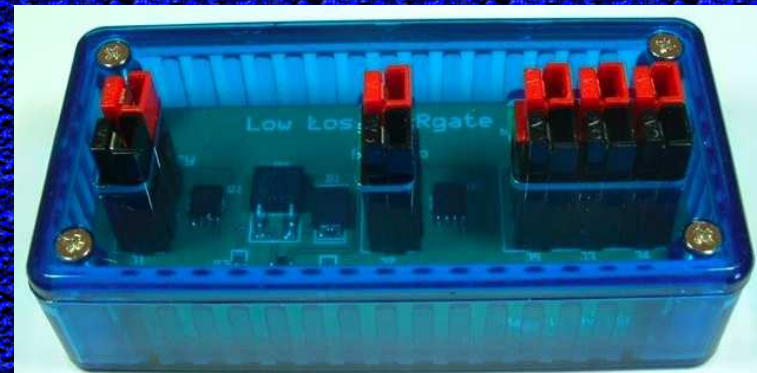

Low Loss PWRGate by KIØBK
\$49.00

<http://ki0bk.no-ip.com/~pwrgate/LLPG/Site/Welcome.html>

Up to 16 vdc and up to 25 amps

Screwdriver Memory Controller

Ameritron SDC-102 / MFJ-1924

\$129.95



Screwdriver Memory Controller

Ameritron SDC-103 \$149.95

For Icom Radios



Screwdriver Controller

MFJ-1922B SDC-103 \$109.95

For Any Radio

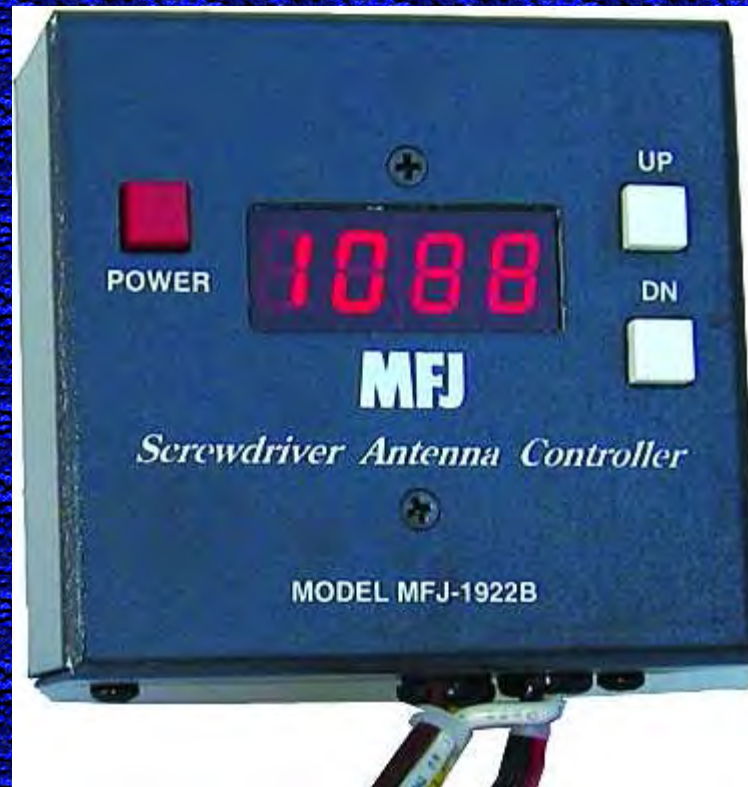

Automatic Screwdriver Controller

Tennatronix KTT-1, ITT-1, YTT-1 ≈ \$300

Available for most Kenwood, Icom and Yaesu Radios



Automatic Screwdriver Controller

West Mountain Radio TARGETuner ≈ \$234.95

For Any Radio – It senses RF and adjusts antenna for best SWR



.....a small, motor driven
Roller Inductor

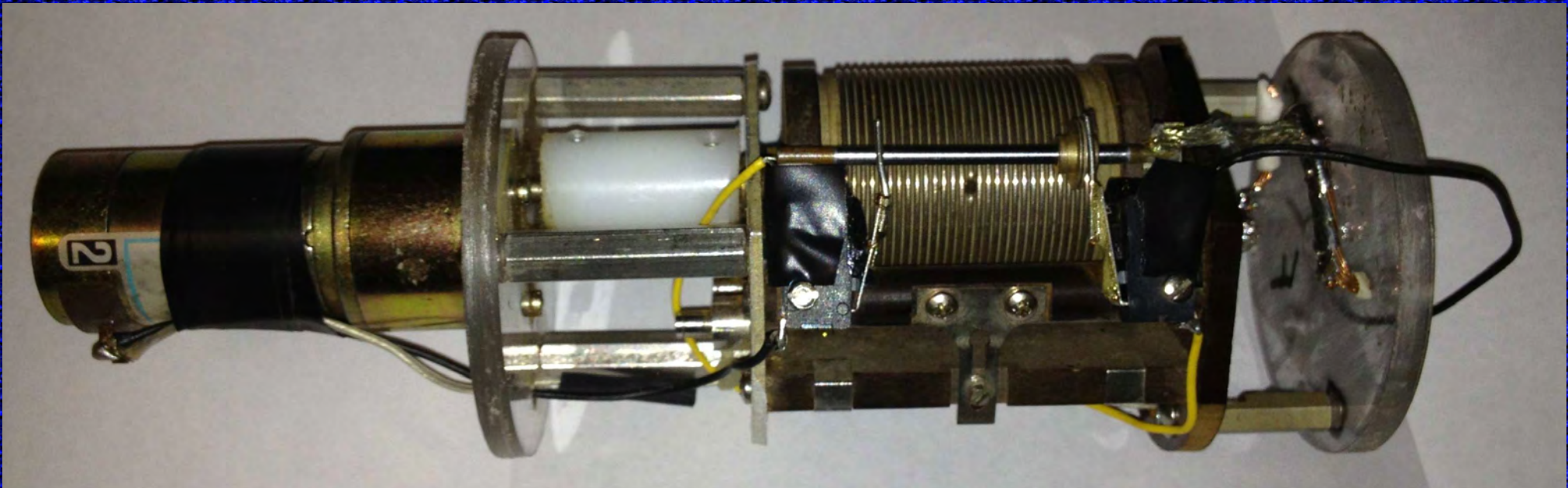

Micro Switches at the ends
of the Roller Inductor, limit travel

A 50Ω match at any frequency

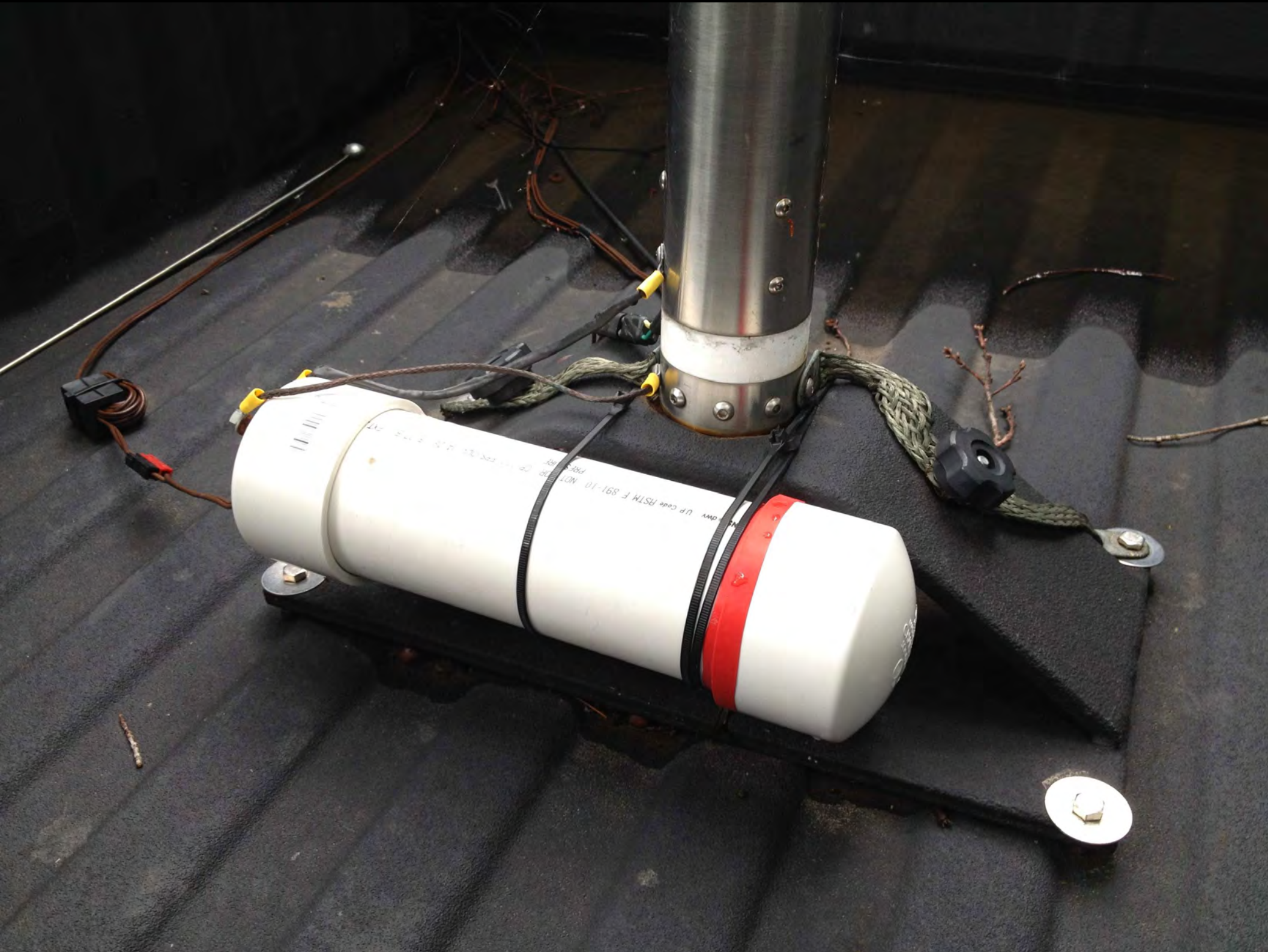

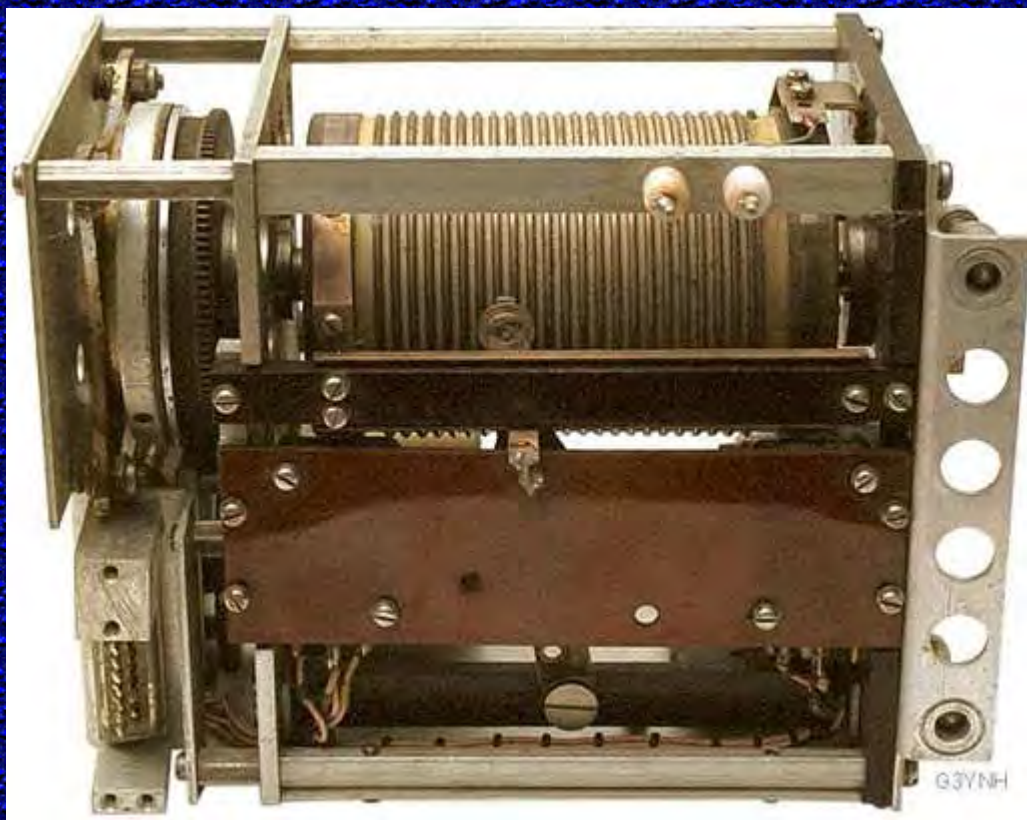

There are other Sources; it will just take some searching



Motorised variable auto transformer from Collins 180L-3A automatic 2-25MHz

Viking Technologies

<http://cardwellcondenser.com/>

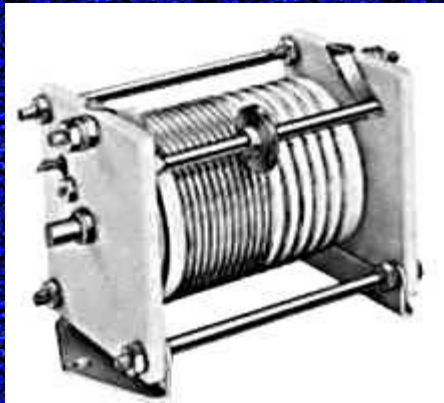

EFJ Cat. No.	Mult. Type	Induct- ance	Current in Amps	Mounting Dimensions (in.)	Overall Dimensions (in.)			Wire Size
					L	H	W	
229-201-1	MJ10-3V	10 uh	3	3-15/16	4-3/8	2-1/2	2-31/32	No. 14
229-202-1	MJ18-5V	18 uh	5	5-15/32	5-29/32	2-1/2	2-31/32	No. 12
229-203-1	MJ28-6V	28 uh	5	6-23/32	7-5/32	2-1/2	2-31/32	No. 12
229-207-1	MJ4-4-8V	4.4 uh	8	4-3/32	4-17/32	2-1/2	2-31/32	No. 8

ServoCity

Small Gear Motors, Switches and Controllers

<http://www.servocity.com/index.html>



Stepper Mounts
NEW!

Bevel Gears
NEW!

Dongbu Coupler
NEW!

Bearing Mounts
NEW!

Connector Plate A
NEW!

Linear Actuators
Powerful!

Super
Duty!

Switched inductors can also work well.
Shown below is an example although used in
a different application



Binary switched inductor chain of the [SGC 230](#) automatic antenna matching unit. Inductors are 32, 16, 8, 4, 2, 1, 0.5, and 0.25µH, giving an inductance range 0 - 63.75µH in 0.25µH steps. The largest coils are wound on stacked Amidon (Micrometals) T-157-2 carbonyl iron toroids. The closed magnetic circuit in these cases prevents coupling to other coils. Most of the smaller inductors are arranged so that adjacent coils have their axes approximately at right angles.

Software:

Air Core Inductor Calculator

There are many on-line calculators or you can download this one:

<http://lcbsystems.com/Air%20core%20inductor%20v105.exe>

Electronics Assistant:

www.electronics2000.co.uk/assist/assist.exe

**Also check out AD5X's presentation:
“Mobile Ops Hints and Kinks”**

<http://www.ad5x.com/images/Presentations/AD5XMobileOpsHintsandKinks.pdf>



QST

DEVOTED ENTIRELY TO AMATEUR RADIO

July 2011

WWW.ARRL.ORG

QST reviews:

46 | **Kenwood TH-D72A**
Dual Band Handheld Transceiver

50 | **Down East Microwave L222-28**
1-1/4 Meter Transverter

51 | **Tennadyne T-28**
VHF/UHF Log Periodic Antenna

Inside:

33 | **DIY Open-Wire Line**

37 | **Is Your Understanding of the K-index in Flux?**

43 | **In Building Mode? Try a Kit**

61 | **Operating Portable Way Up North**

VE6AB

Bonds with His Beautifully Crafted 75 Meter Mobile Antenna

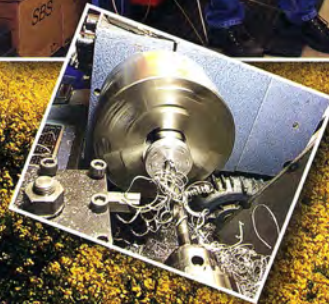

Take a look at the QST article on page 39 of the July 2011 issue. It is a monoband mobile antenna optimized for 75 Meters. The diameter of this main coil is much larger than what you saw in the previous photo. It all equates to efficiency, and efficiency translates into more enjoyable QSOs .



*****CARR-RT LOT**R-001
0008046183 KOMJ FO 08/2011
JN1 QST_1 JUL11 0011 #590 #137721
LON M MARTIN
20900 W S2ND ST
SHAMNEE MSN KS 66218-9427

Official Journal of
ARRL The national association for
AMATEUR RADIO



The author measuring the impedance of his 17 meter band antenna.

Jerry Clement, VE6AB

I designed and built this 17 meter monobander antenna to improve the performance of the 17 meter segment of a 10 through 80 meter gearmotor antenna that I had also designed and built. My goal was to build the antenna with components available from a local ham radio outlet or from the Internet. You can build this antenna with basic hand tools and make it look store-bought, as seen in the lead photo.

Because your vehicle is the other half of this mobile antenna system, your vehicle may require bonding to improve the ground plane beneath the antenna. Bonding may increase the performance of the antenna system, and may eliminate or reduce noise in your radio receiver.

Assembling the Antenna

I utilized PL-259 UHF connectors as well as double female UHF barrel connectors as part of the coil assembly. This allows you to make coils for other bands and easily

A Monobander for Going Mobile on 17 Meters

Construct this elegant 17 meter band antenna for your mobile operations.

switch them for the 17 meter coil. The coil form seen in Figure 1 is a composite material that has a thread form already in place. Figure 2 shows the construction details of the coil form assembly. It comprises a mast adapter and a whip adapter made from 6061 aluminum, a polycarbonate $\frac{1}{8}$ -inch diameter coil form core, and a 1-inch diameter nylon coil form with eight turns per inch grooves. The aluminum adapters allow you to install PL-259 UHF connectors at either end of the coil form, joining it with the mast and whip.

Making the Coil

The coil assembly is the heart of this antenna. Cut the 1 inch diameter rod slightly longer than 3-inches and true the ends to the required 3-inch length. Drill a $\frac{1}{8}$ -inch hole completely through the center axis of the rod. Then take the 4-inch length of the $\frac{1}{8}$ -inch diameter rod and thread both ends, as illustrated in Figure 2. Make the 1-inch coil form square to the sides using a flat file and a square. The ends should form perfect 90 degree angles with the sides. Take your time and you will be rewarded with an antenna that stands perfectly straight.

Position the coil form core through the center of the 1-inch coil form so that the half-inch threaded ends protrude from each end equally. Some force may be required to insert the $\frac{1}{8}$ -inch rod. The assembly will keep in place without additional fasteners. The nylon coil form supports only the wire, while the polycarbonate core is the actual structural part of the antenna that supports the whip at the top of the antenna assembly.

Screw a double-ended female UHF barrel connector into each of two PL-259 connectors at the ends of the coil form. Drill and tap a single hole through the PL-259 connector at the end of the knurled nut, and then continue through the barrel connector

just enough to penetrate the shell of the UHF barrel connector. Don't drill this hole too deep, as you just need the machine screw to protrude through the knurled nut of the PL-259, and then through the UHF barrel connector to lock them together. I used Allen drive 6-32 machine screws, although 6-32 set screws will work also. You can see these screws in Figure 1.

With the PL-259 assemblies screwed in and butted up against the ends of the 1-inch coil form, drill holes for 6-32 machine screws into the PL-258 adapters to keep the coil assembly securely fastened together and to secure the ends of the wire coil. Don't drill through the PL-259 into the polycarbonate $\frac{1}{8}$ -inch rod more than necessary so as not to weaken it. The screw placement is not critical; use Figure 1 as a guide.

Wind 24 turns of solid #14 AWG copper wire (approximately 4 μ H of inductance). Solder or crimp an uninsulated eyelet to one end of the wire. Fasten the eyelet to the PL-259 connector at one end of the coil form. Once you reach the opposite end of the coil form, determine where to cut the wire, and crimp or solder a second uninsulated eyelet on the wire. Fasten that eyelet in place on the PL-259 connector with a 6-32 machine screw. Inspect your



Figure 1 — Partially completed coil assembly attaches on top of the mast and supports the whip assembly.

DIY

Jerry also had an article in the May 2014 issue of QST where he describes how to build a 17 Meter Monoband mobile antenna.

coil assembly, and test for continuity with a multimeter.

I covered the coil assembly with heat shrink adhesive-lined 3 to 1 shrink-rate tubing to weatherproof the coil and to make the appearance pleasing, as seen on the right side of Figure 3. The covering will affect the Q of the coil. Cut the shrink tube to length, allowing the threaded ends of the UHF barrel connectors to protrude at either end of the shrink tube. Once you slide the shrink tube in place over the coil assembly, start heating the shrink tube from the center of the coil assembly and working out to the ends using a heat gun. While applying heat, rotate the coil, making sure that the shrink tubing follows the contours of the coil. Ensure that you have applied the proper amount of heat to melt the adhesive, which will be visible at either end of the shrink tube. Do not apply more heat than necessary to shrink the tubing so as not to damage the coil form.

Whip and Mast Adapters

You can purchase ready-made whip and mast adapters from me, or you can make them yourself.¹ For the whip adapter, purchase a stainless steel 1 inch \times $\frac{7}{16}$ inch bolt threaded 14 turns per inch for its full length. Cut the bolt leaving a half inch under the head that will allow the bolt to screw into the PL-259 connector. Drill a hole completely through the center of this bolt, equal to the diameter of the base of the whip. Then, drill and tap a hole crossways through the head of the bolt (see Figure 2) for a stainless steel 8-32 set screw that locks the whip in place in the adapter. The whip and the PL-259 connector are now a quick-disconnect assembly for your 17 meter antenna.

The mast adapter screws into a PL-259 UHF connector, and attaches to the $\frac{3}{8}$ inch by 24 turns per inch thread of the mast. The adapter attaches the mast to the lower section of the coil. Form the mast adapter from $\frac{1}{4}$ inch long aluminum according to Figure 2. Make a $\frac{7}{16}$ inch by 14 turns per inch thread at one end, and an internal $\frac{3}{8}$ inch by 24 turns per inch female thread at the opposite end.

Whip and Mast

I selected a 54-inch stainless steel whip for my antenna element, p/n ARS-SSWT-54

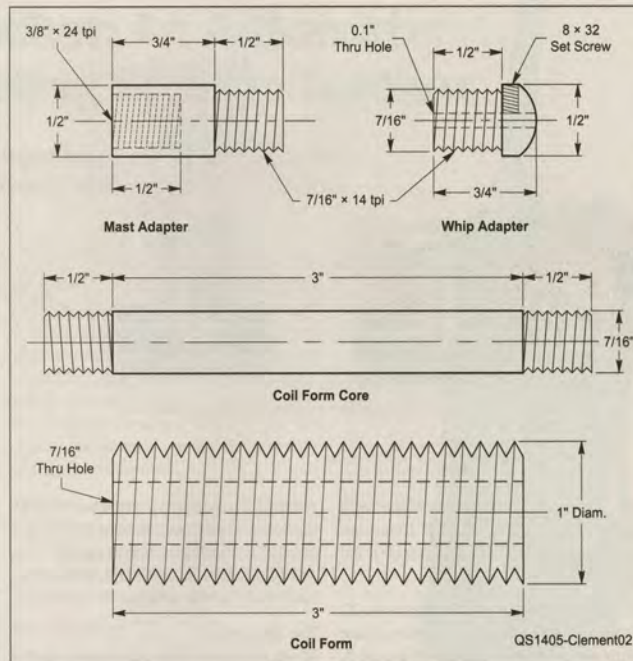

Figure 2 — Coil form construction. McMaster-Carr parts from www.mcmaster.com, American Radio Supply parts from www.americanradiosupply.com.

Coil form, Nylon threaded rod, 1" – 8 thread (McMaster-Carr p/n 98831A140)

Coil form core, Polycarbonate rod $\frac{7}{16}$ " diam. (McMaster-Carr p/n 8571K45)

Heat shrink tube, moisture seal (McMaster-Carr p/n 7861K48)

(4) PL-259 UHF-male coaxial connector for RG-8 (American Radio Supply p/n ARS-1182-RG8)

(2) UHF double female barrel coaxial adapter connector (American Radio Supply p/n ARS-7517)



Figure 3 — Close-ups of (left) optional base spring, and (right) the completed loading coil.

¹Notes appear on page 32.



Figure 4 — A white PVC cover (left) protects the shunt coil assembly (right).

from American Radio Supply.² The whip attaches in place in a PL-259 connector, which becomes a quick-disconnect at the top of the coil.

The lower mast assembly measures 22 inches in length, and with the optional base spring shown on the left side of Figure 3, measures 32 inches overall length. You do not need to use a spring but having one can save the antenna from being damaged. The length for the mast can vary depending on the mounting needs of your mobile, and the length will affect antenna resonance. You can purchase a Hustler mast assembly, p/n MO-4 22 inch mast from DX Engineering.³

The Antenna on Your Vehicle

Fasten the antenna to your vehicle using an antenna mount of your choice. You may need to make some adjustments to your antenna once you have installed it on your vehicle. An antenna analyzer connected up to the feed point of your antenna will allow you to make the necessary adjustments required more easily, as seen in the lead photo.

I use a shunt coil with my gearmotor antennas, and I was pleased to discover how well the same shunt coil worked with this 17 meter monoband antenna mounted in

place of my gearmotor antennas. This 17 meter monoband antenna benefits from the shunt coil, and allows you to operate from 18.068 MHz to 18.168 MHz, without the need to retune the antenna.

The Shunt Coil

Shunt coils are easily constructed, and if you are serious about HF mobile, and high performance HF mobile antennas in particular, you need a shunt coil as part of your favorite HF antenna system. My shunt coil consists of nine turns of #14 AWG wire with a 3/4-inch inner diameter and 1-inch outer diameter. The coil measures about 1 μ H of inductance. One end of the coil connects to the antenna feed point, and the other end connects to the same ground used for the coax shield, as seen in Figure 4. I built my shunt coil on a SO-239 panel mount coax connector, as seen in Figure 4, and connected it to the T port of an Amphenol UHF T connector. The T connector connects in series with the base of the antenna mast. I enclosed my shunt coil in a white PVC housing available from Home Depot, as seen in Figure 4.

Making Adjustments

Once you mount your antenna on your vehicle, connect an antenna analyzer to the antenna feed line, and adjust your

shunt coil by compressing or stretching the coil to get a good match. The shunt coil, along with a small amount of capacitive reactance from the antenna, forms a high pass LC network that transforms the low impedance of the antenna to the 50 Ω at the feed line. For further information on shunt coils, follow the "Antenna Coil Adjustment" link from Alan Applegate's, K0BG, web page, www.k0bg.com.

The shunt coil also dc-grounds your antenna, which may help to save you and your radio if your antenna were to come into contact with any live overhead power lines.

[You can find many detailed construction photos of the coil on the *QST* in Depth web page. — Ed.]⁴

Closing Remarks

I hope you enjoy operating mobile on 17 meters as much as I do, and if you hear me while you are using your new 17 meter mobile antenna, give me a call.

Notes

¹You can order the whip and mast adapters from Jerry Clement, VE6AB, stormchaser@shaw.ca.

²www.americanradiosupply.com

³www.dxengineering.com

⁴www.arri.org/qst-in-depth

Photos by the author.

International ARRL member Jerry Clement, VE6AB, has been a licensed Amateur Radio operator since 1992. Jerry is a machinist who owns and operates a machine shop where he builds scale models and makes mobile antennas. Jerry also specializes in automatic controls for refrigeration systems. Currently he provides technical support to agricultural clients located throughout Western Canada. An HF mobile enthusiast, he builds mobile antennas and evaluates their performance. He enjoys working through Amateur Radio satellites with antennas built in his shop. Jerry is also a photographer, and when not doing event work, he enjoys photographing landscapes, wildlife, and nature scenes, as he explores the back roads of southern Alberta. You can reach Jerry at 3812 14 Ave NE, Calgary, AB T2A 7L6, Canada or stormchaser@shaw.ca.

For updates to this article, see the *QST* Feedback page at www.arri.org/feedback.

VOTE
Did you enjoy this article?
Cast your vote at
www.arri.org/cover-plaque-poll

Resources

✦ <http://www.k0bg.com/>

<http://www.ad5x.com/images/Presentations/AD5XMobileOpsHintsandKinks.pdf>

✦ <http://www.w8ji.com/>

http://www.w8ji.com/verticals_and_baluns.htm

Ferrite Toroids & Beads:

✦ <http://www.dxengineering.com/>

<http://www.dxengineering.com/Parts.asp?PartNo=DXE-CSB-COMBO>

✦ <http://www.fair-rite.com/newfair/index.htm>

✦ <http://www.mouser.com/>

http://www.palomar-engineers.com/1_1_Balun_Kits/1_1_balun_kits.html

✦ <http://www.scorpionantennas.com/>

Summary

- ✦ **Use the correct size of STRANDED cable to power your mobile station**
- ✦ **Use RG-58 or RG-8X Coax with a STRANDED center conductor**
- ✦ **Proper antenna mounting position and method can't be overstated**
- ✦ **Ground EVERYTHING & Bond EVERYTHING**
- ✦ **Use Mix 31 Toroids and Beads to minimize Common Mode Currents**

Thanks For Listening

**Consultations after this meeting regarding your particular installation are welcomed.
My fee is \$50/hr with a one hour minimum
(waived if you have a Ham license)**